

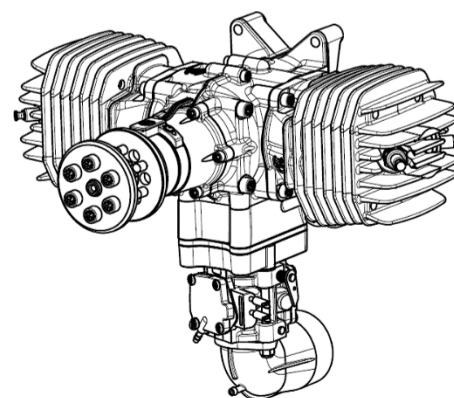

Anlage A
3W-157XiB2 TS

1. Dreiseitenansicht

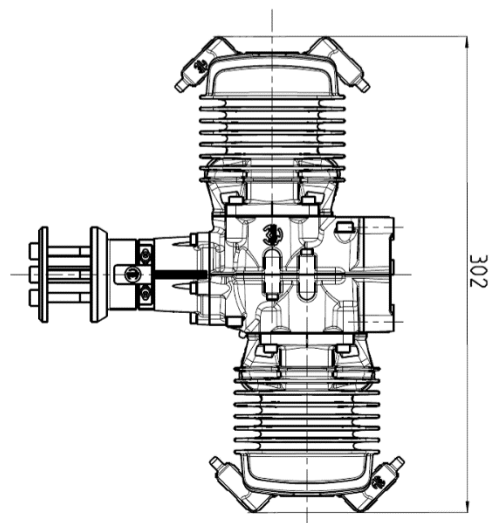
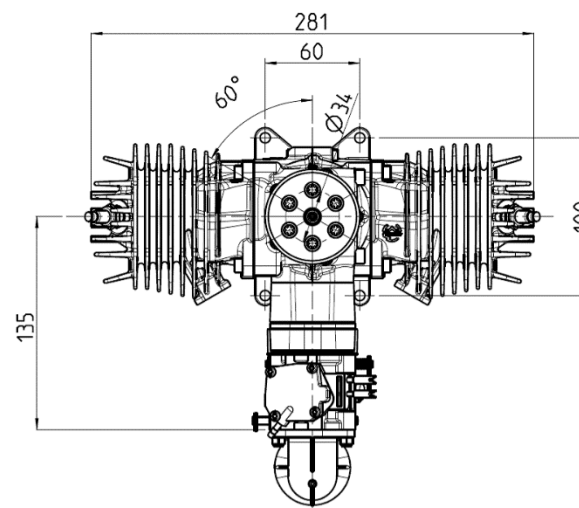
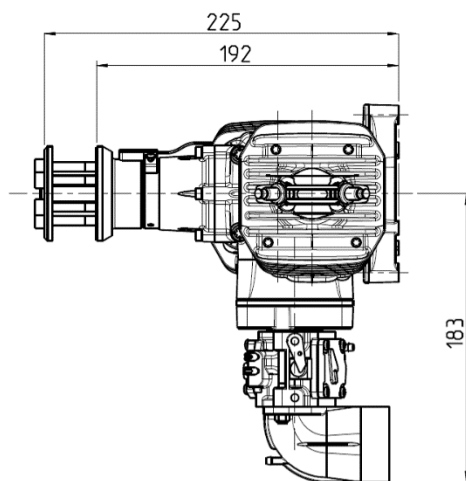

2. Bohrschablone

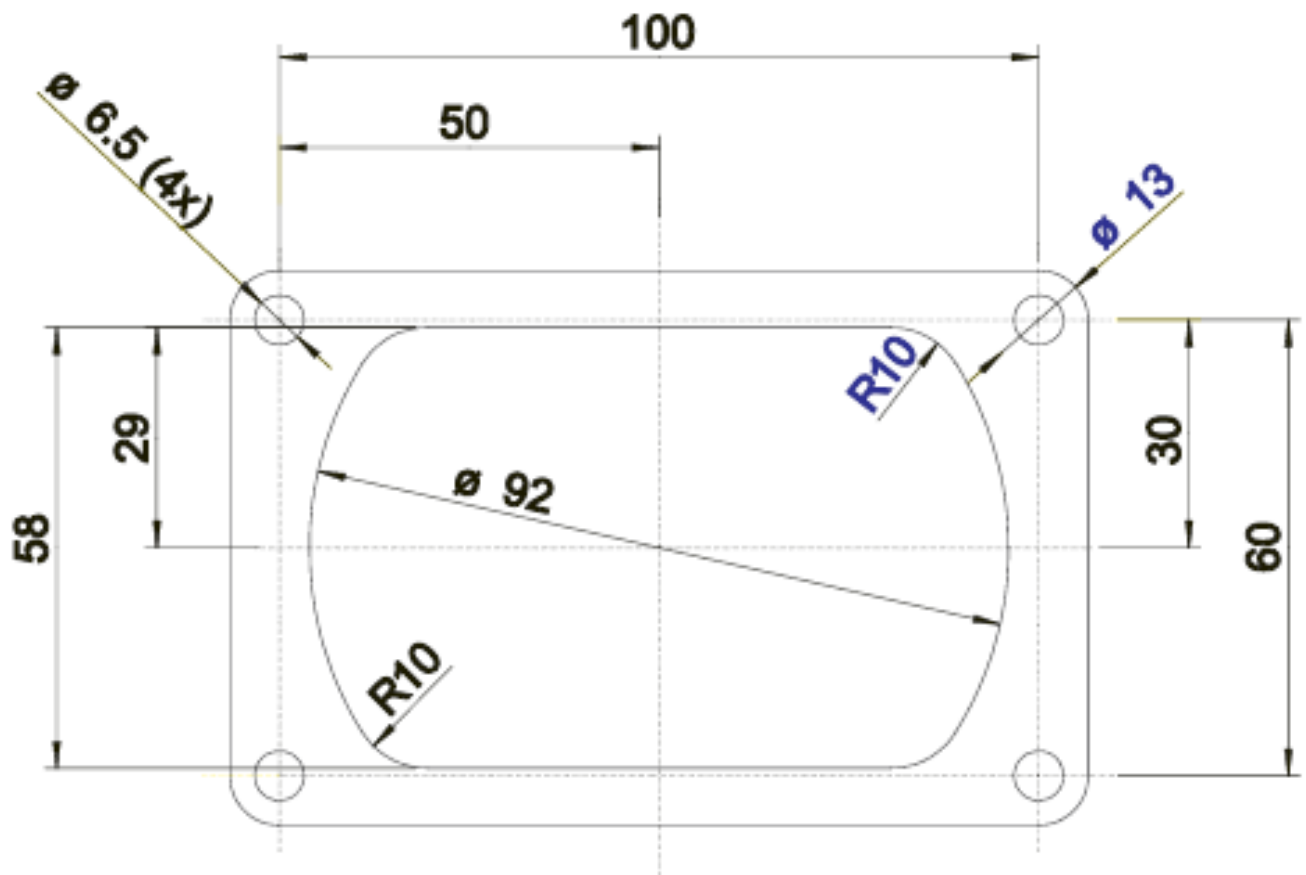



3. Technische Daten

	3W-157XiB2 TS
Hubraum	157,0ccm
Leistung	17,5 PS (12,9 KW)
Bohrung	50,00 mm
Hub	40,00 mm
Drehzahlbereich	1.100 – 8.500 U / min
Gewicht inkl. Zündung	4.105 g
Kurbelwelle	3 Kugellager
Pleuel	Nadellager an beiden Enden
Benzingemisch	1 : 50 – 1: 80 (min. 92 Oktan)
IIS – Zündung	6,0 – 8,4V, 5 Zellen oder 2 Zellen LiPo
2-Blatt Propeller	28 x 12 Holz Bestellnummer 10.101.585 28 x 14 Holz Bestellnummer 10.101.589 30 x 12 Holz Bestellnummer 10.101.597 32 x 10 Holz Bestellnummer 10.101.601 32 x 12 Holz Bestellnummer 10.101.605 31,75 x 14 x 8 CFK Bestellnummer 10.101.685 (3D)
3-Blatt Propeller	27 x 14 CFK Bestellnummer 10.101.740 28 x 10 CFK Bestellnummer 10.101.745