

## Instruction Manual



# ASK-21 ELECTRIC 3200

## 1/5 SCALE ARF

### SPECIFICATION

- **Wingspan:** 3200mm (125,9 in)
- **Length:** 1650mm (64,9 in)
- **Flying weight:** 3000gr – 3200gr
- **Wing area:** 64.5 dm<sup>2</sup>
- **Wing loading:** 46g/dm<sup>2</sup>
- **Wing type:** HQ profile
- **Radio:** 4 channel – 4 mini hi-torque servo :  
2 aileron; 1 elevator; 1 rudder (not included)
- **Servo mount :** 12mm X 24mm
- **Flap:** 2 electric flaps 440mm (not included)
- **Spinner size:** Aluminum H hub propeller holder, shaft 6mm (not included)
- **Propeller:** suit with your engine
- **Gravity CG:** 75 mm (2.95 in) Back from the leading edge of the wing, at the fuselage
- **Control throw Ailerons:** Low: 10mm up/down, 10% expo; High: 12mm up/down, 10% expo
- **Control throw Elevators:** Low: 8mm up/down, 12% expo; High: 12mm up/down, 12% expo
- **Control throw Rudder:** Low: 30mm right/left, 15% expo; High: 55mm right/left, 15% expo
- **Motor:** brushless outrunner 700-800 W, 750 KV
- **Experience level:** Intermediate
- **Plane type:** Scale sailplane

### **RECOMMENDED MOTOR AND BATTERY SET UP**

- **Motor:** OS OMA – 3825-750 (Not included)
- **Propeller:** 12x8 ; 13x8 (not included)
- **Lipo cell:** 3-4 cells / 2400 – 3000mAh (not included)
- **Esc:** 50-80 A (not included)

**TOOLS AND SUPPLIES NEEDED.**

- Medium C/A glue.
- 30 minute epoxy.
- 6 minute epoxy.
- Hand or electric drill.
- Assorted drill bits.
- Modeling knife.
- Straight edge ruler.
- 2 bender plier.
- Wire cutters.
- Masking tape.
- Thread lock.
- Paper towels.
- Rubbing alcohol

**SUGGESTION**

To avoid scratching your new airplane, do not unwrap the pieces until they are needed for assembly. Cover your workbench with an old towel or brown paper, both to protect the aircraft and to protect the table. Keep a couple of jars or bowls handy to hold the small parts after you open the bag.

**NOTE:**

Please trial fit all the parts. Make sure you have the correct parts and that they fit and are aligned properly before gluing! This will assure proper assembly. The ASK-21 ELECTRIC 3200 ARF 1/5 SCALE is hand made from natural materials, every plane is unique and minor adjustments may have to be made. However, you should find the fit superior and assembly simple.

The painted and plastic parts used in this kit are fuel proof. However, they are not tolerant of many harsh chemicals including the following: paint thinner, C/A glue accelerator, C/A glue debonder and acetone. Do not let these chemicals come in contact with the colors on the covering and the plastic parts.

**SAFETY PRECAUTION:**

- This is not a toy
- Be sure that no other flyers are using your radio frequency.
- Do not smoke near fuel
- Store fuel in a cool, dry place, away from children and pets.
- Wear safety glasses.
- The glow plug clip must be securely attached to the glow plug.
- Do not flip the propeller with your fingers.
- Keep loose clothing and wires away from the propeller.
- Do not start the engine if people are near. Do not stand in line with the side of the propeller.
- Make engine adjustments from behind the propeller only. Do not reach around the spinning propeller.

**PREPARATIONS**

Remove the tape and separate the ailerons from the wing and the elevators from the stab. Use a covering iron with a covering sock on high heat to tighten the covering if necessary. Apply pressure over sheeted areas to thoroughly bond the covering to the wood.

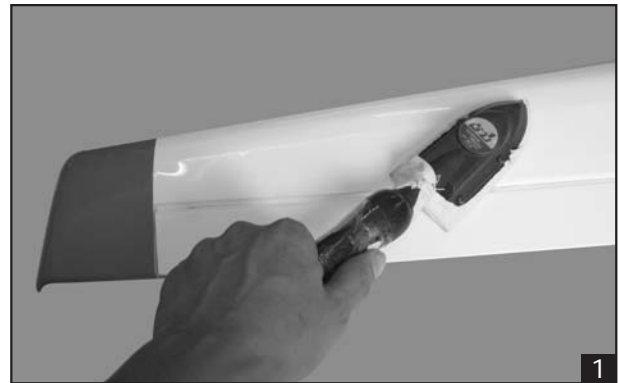
**INSTALLING THE AILERONS**

1. Test fit the ailerons to the wing with the hinges. If the hinges don't remain centered, stick a pin through the middle of the hinge to hold it in position.

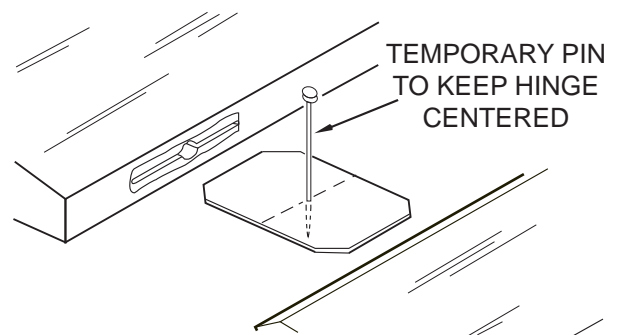

2. Apply six drops of thin CA to the top and bottom of each hinge. Do not use CA accelerator. After the CA has fully hardened, test the hinges by pulling on the aileron.

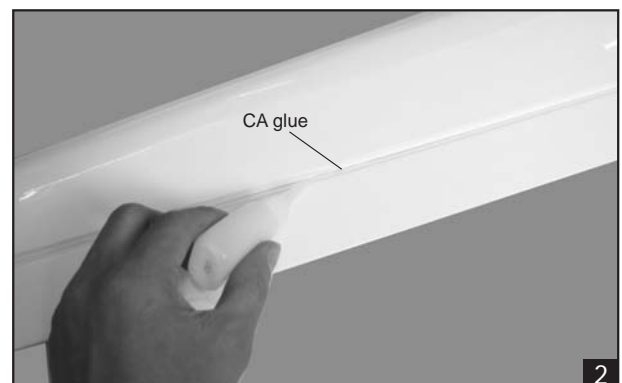

**INSTALLING THE AILERON SERVOS**

1. Install the rubber grommets and brass eyelets onto the aileron servo.
2. Using a modeling knife, remove the covering from over the pre-cut servo arm exit hole on the aileron servo tray / hatch. This hole will allow the servo arm to pass through when installing the aileron pushrods.

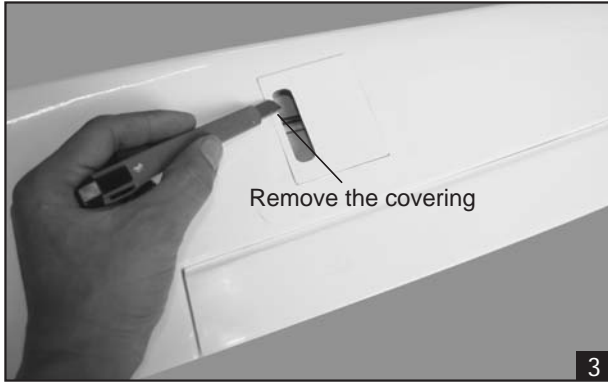

3. Place the servo into the servo tray. Center the servo within the tray and drill 1,6mm pilot holes through the block of wood for each of the four mounting screws provided with the servo.

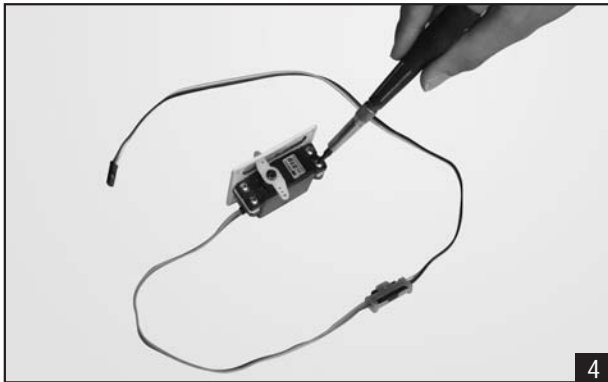

4. Using the thread as a guide and using masking tape, tape the servo lead to the end of the thread: carefully pull the thread out. When you have pulled the servo lead out, remove the masking tape and the servo lead from the thread.



5. Place the aileron servo tray / hatch into the servo box on the bottom of the wing and drill 1,6mm pilot holes through the tray and the servo box for each of the four mounting screws. Secure the servo tray in place using the mounting screws provided ( 2mm x 12mm ).



6. Repeat step # 2 - # 5 to install the second aileron servo in the opposite wing half.



**INSTALLING THE CONTROL HORNS**

1. One aileron control horn is positioned on each aileron. Using a ruler and a pen, locate and mark the location of the control horn. It should be mounted on the bottom side of the aileron at the leading edge, in line with the aileron pushrod.
2. Drill two 1.6mm holes through the aileron using the control horn as a guide and screw the control horn in place.



- Repeat step # 1 - # 2 to install the control horn on the opposite aileron.

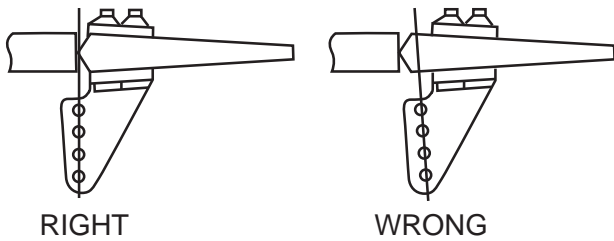

**INSTALLING THE AILERON LINKAGES**

- Working with the aileron linkage for now, thread one nylon clevis at least 14 turns onto one of the 2mm x 180mm threaded wires.

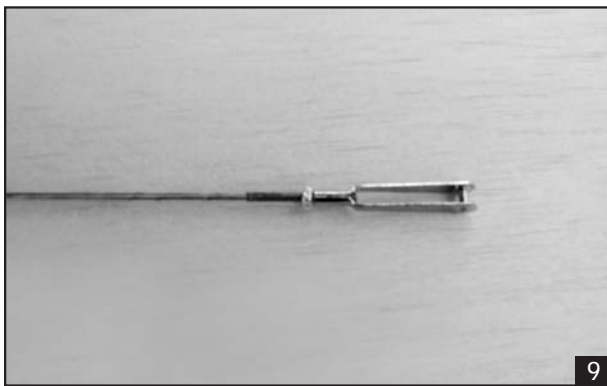

- Attach the clevis to the outer hole in the control horn. Install a silicone tube on the clevis.
- Locate one nylon servo arm, and using wire cutters, remove all but one of the arms. Using a 2mm drill bit, enlarge the third hole out from the center of the arm to accommodate the aileron pushrod wire.
- Plug the aileron servo into the receiver and center the servo. Install the servo arm onto the servo. The servo arm should be perpendicular to the servo and point toward the middle of the wing.
- Center the aileron and hold it in place using a couple of pieces of masking tape.
- With the aileron and aileron servo centered, carefully place a mark on the aileron pushrod wire where it crosses the hole in the servo arm.
- Using pliers, carefully make a 90 degree bend down at the mark made. Cut off the excess wire, leaving about 4mm beyond the bend.
- Insert the 90 degree bend down through the hole in the servo arm. Install one nylon snap keeper over the wire to secure it to the arm. Install the servo arm retaining screw and remove the masking tape from the aileron.

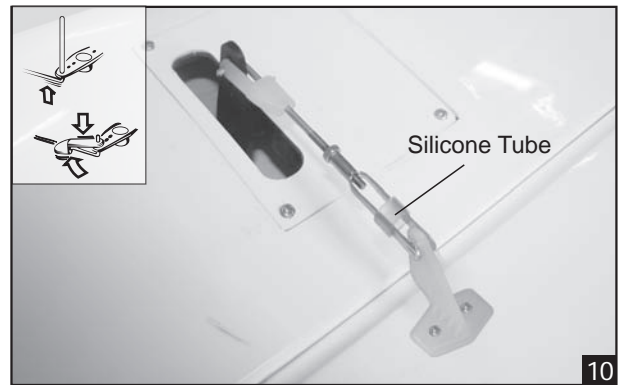

- Repeat step # 4 - # 8 to install the second aileron linkage. After both linkages are completed, connect both of the aileron servo leads using a Y-harness you have purchased separately.



**INSTALLING THE ELECTRIC AIR BRAKES**

**(NOT INCLUDED WITH THE KIT)**

- Remove the covering from the top of the wing.

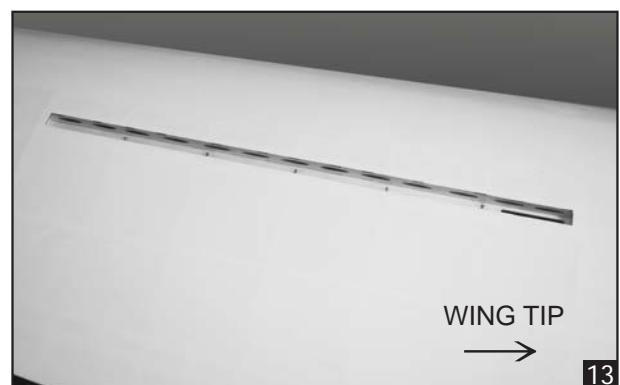

2. Install the air brake into the bay.



**INSTALLING THE WING**

1. Attach the wing to the fuselage as picture.

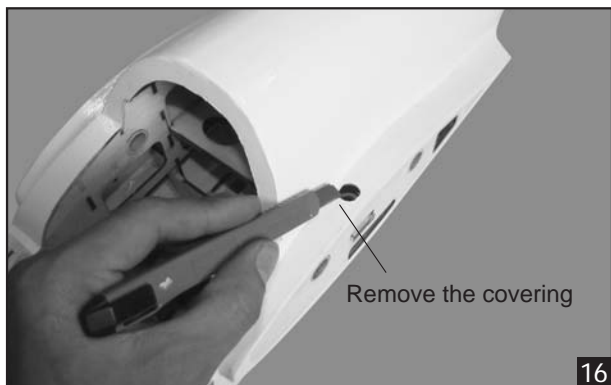

2. Slide the joiner to the wing and to the fuselage.

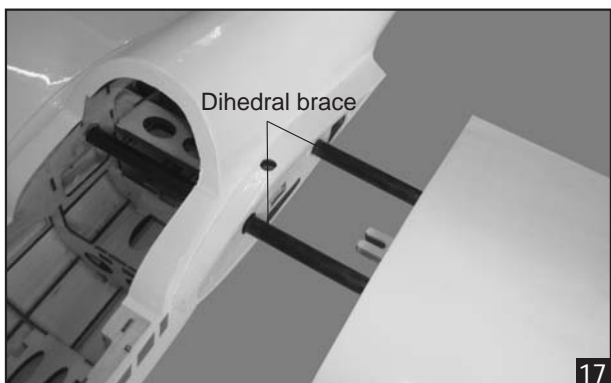

3. Secure the wing.

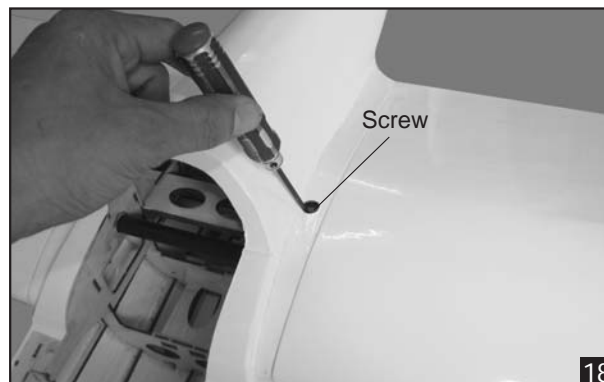

4. Test the position of the elevator and adjust it as shown.

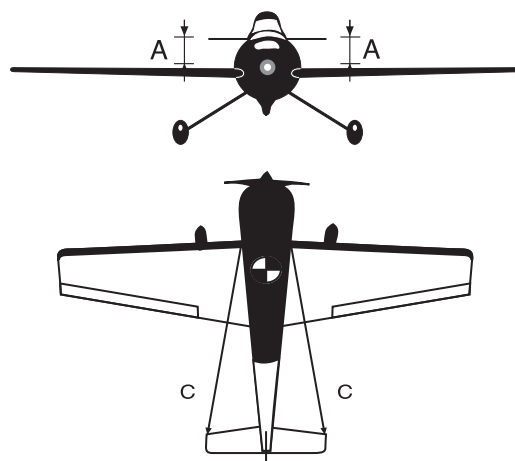

**INSTALLING THE MAIN LANDING GEAR**

1. The full set wheel.



2. Secure the collars.

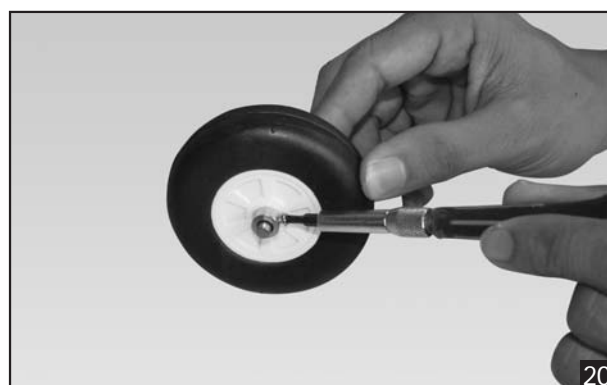

3. Glue the wooden plate to the fuselage.

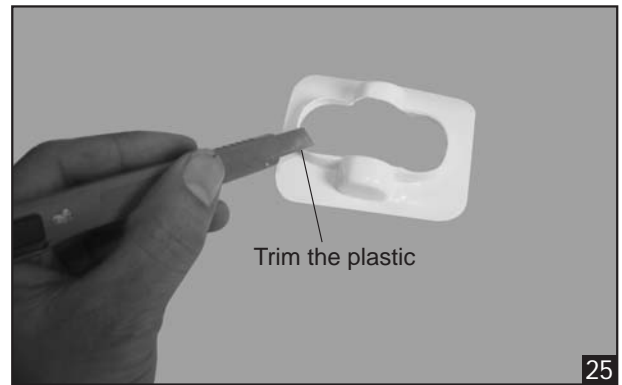
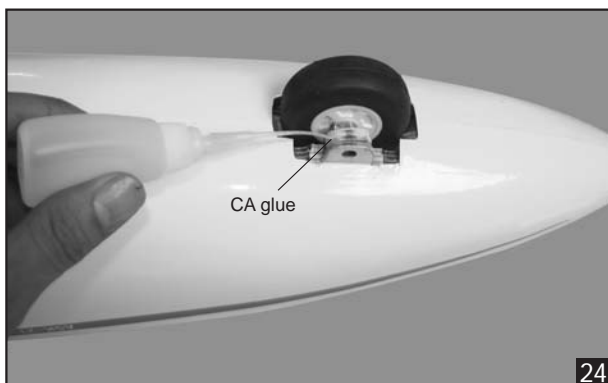
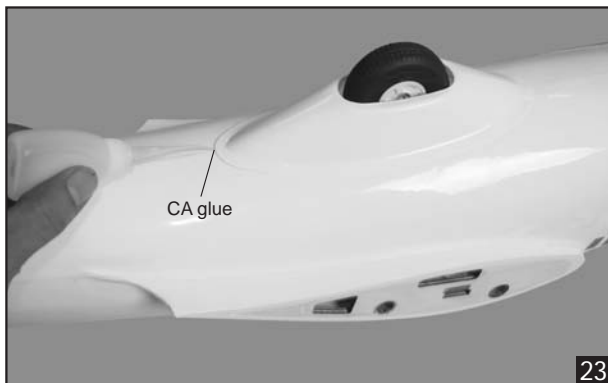
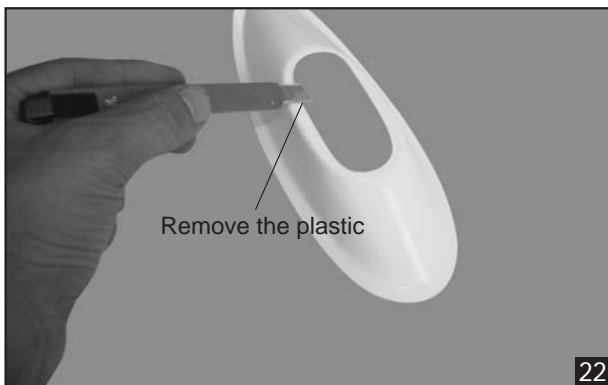
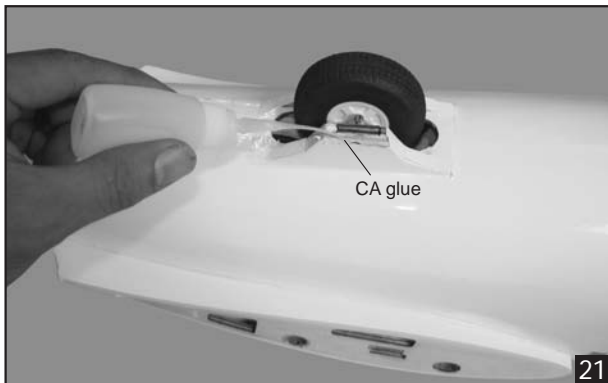

**INSTALLING THE ELEVATOR**

- Repeat step #1 - #2 from installing the aileron to install the elevator.

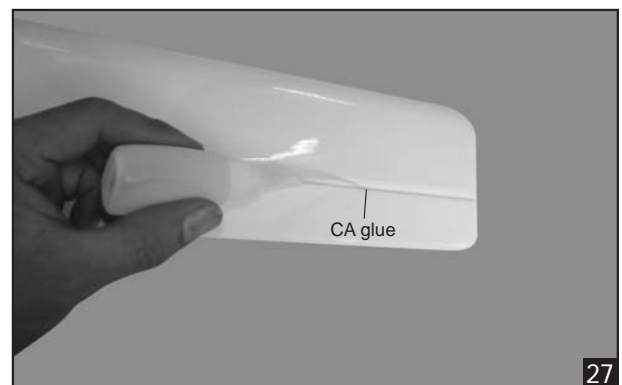

**INSTALLING THE CONTROL HORNS AND LINKAGES**

Repeat these step as installing the aileron control horn and linkages.

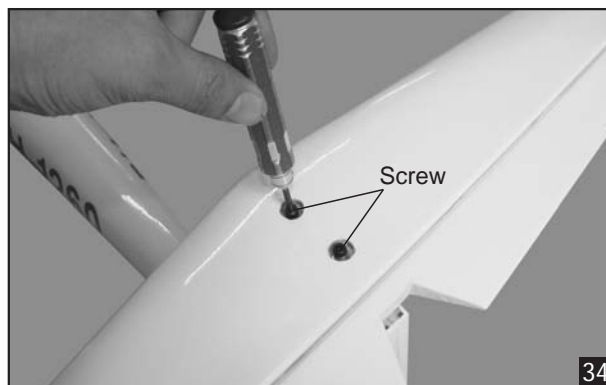
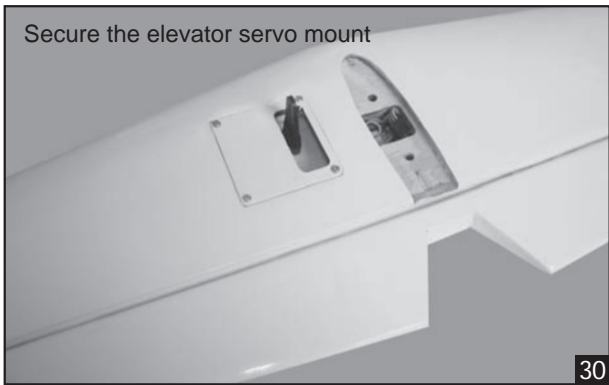
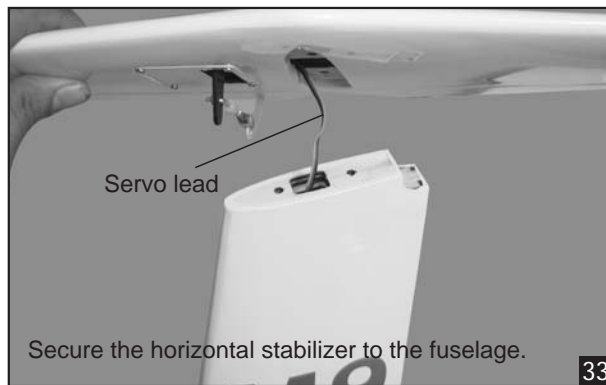
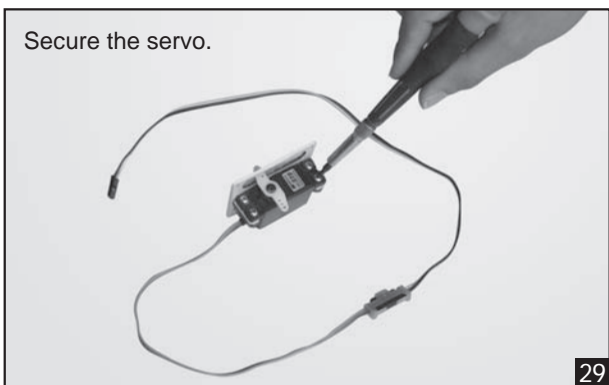
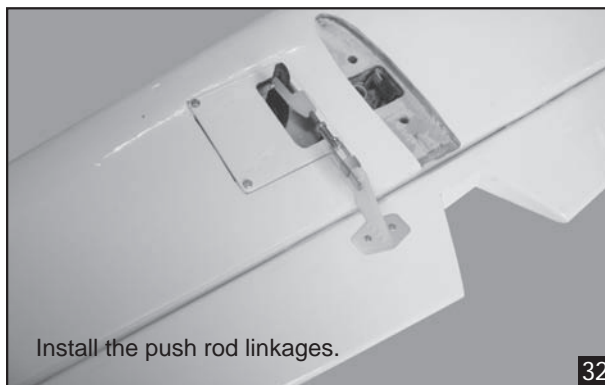
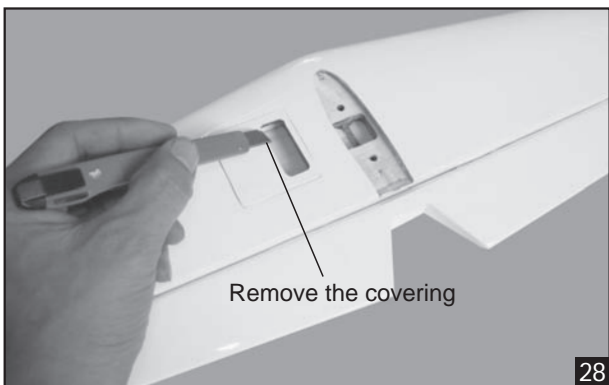

### **INSTALLING THE RUDDER**

Repeat these step from installing the aileron to install the rudder.

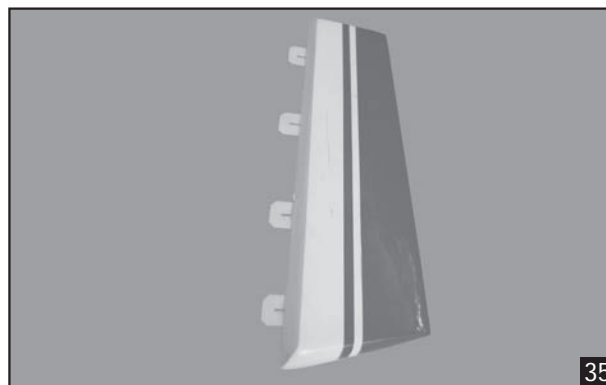

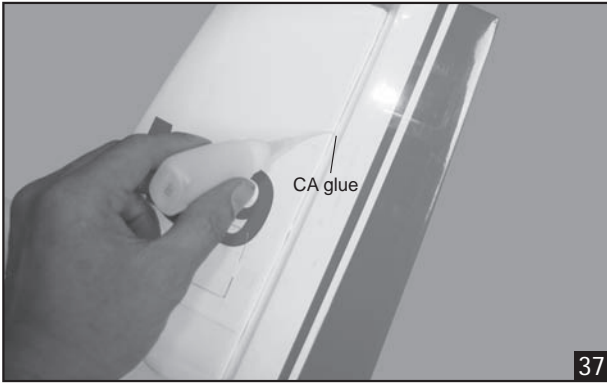
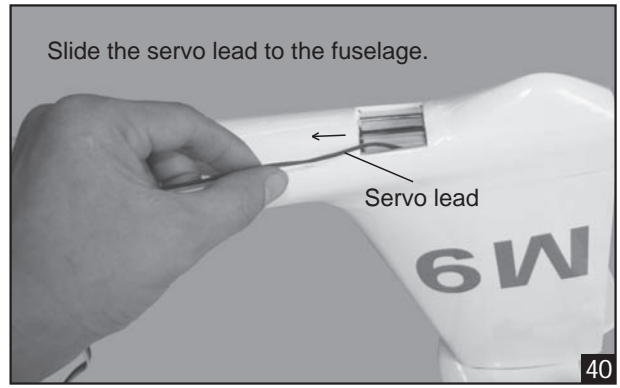
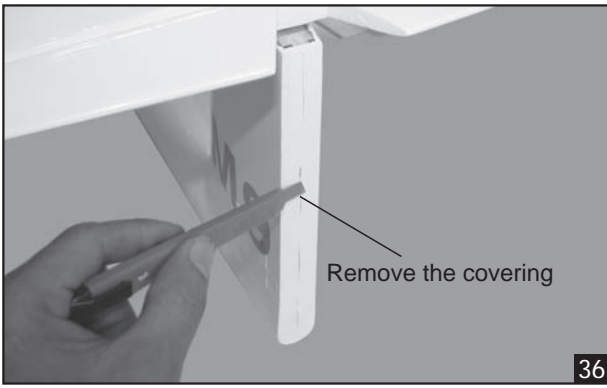

**INSTALLING THE CONTROL HORN AND LINKAGE.**

Repeat these step as installing the aileron control horn and linkages.

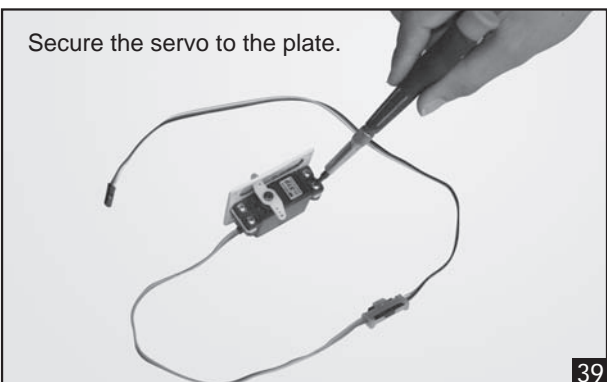
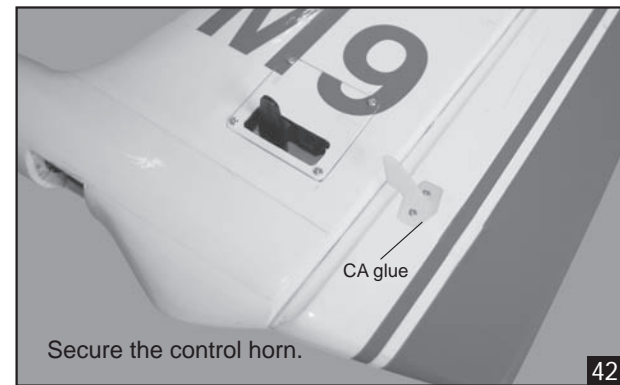
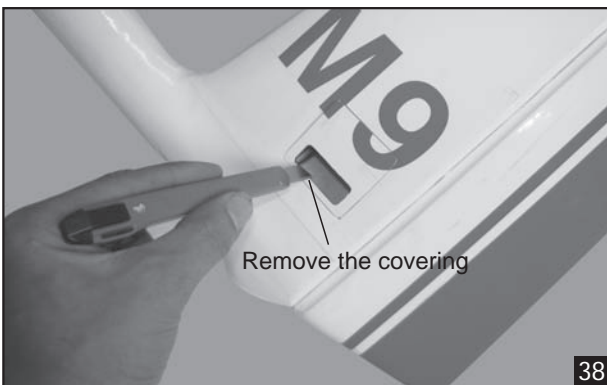



**INSTALLING THE TOWING SERVO**

1. Install the metal connector to the servo arm.

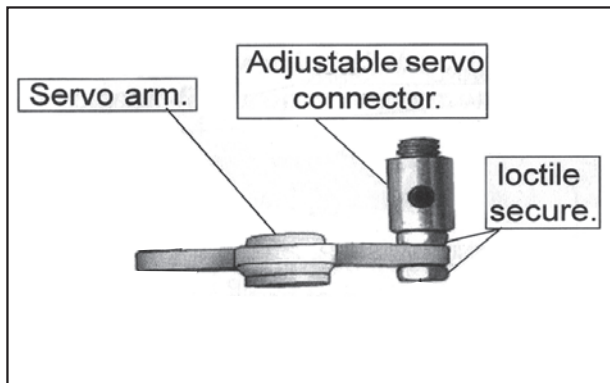

2. Bend "L" the metal rod as the picture below.

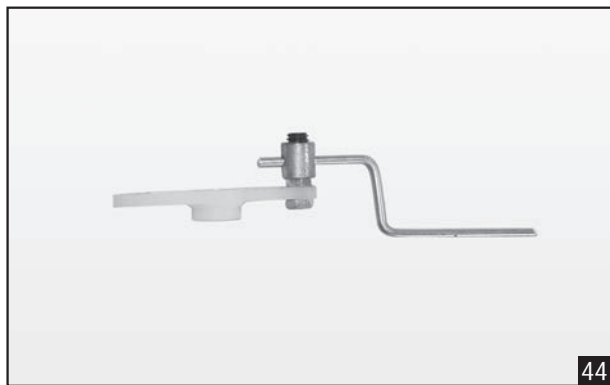

3. Place the servo arm to the servo and secure it.

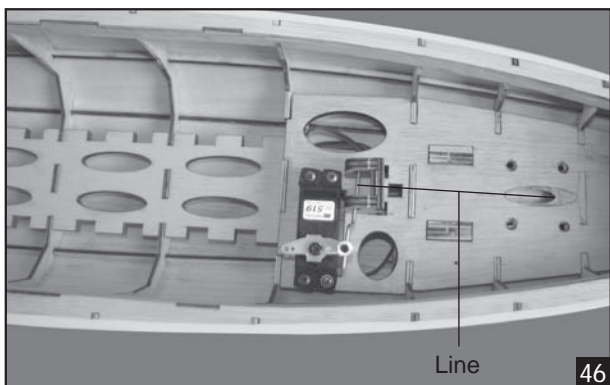
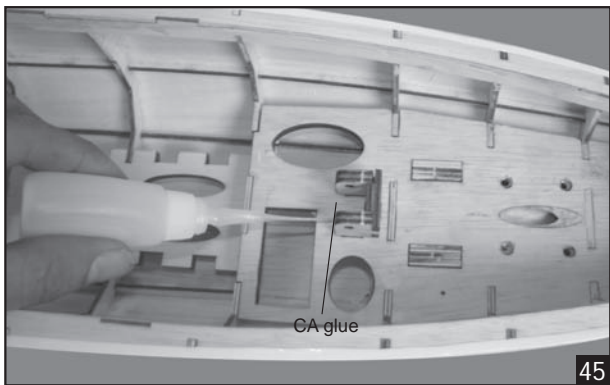

**INSTALLING THE RECEIVER AND BATTERY**

1. Plug the servo leads and the switch lead into the receiver. You may want to plug an aileron extension into the receiver to make plugging in the aileron servo lead easier when you are installing the wing. Plug the battery pack lead into the switch.
2. Wrap the receiver and battery pack in the protective foam to protect them from vibration. Use a rubber band or masking tape to hold the foam in place.

 Do not permanently secure the receiver and battery until after balancing the model.

**INSTALLING THE MOTOR**

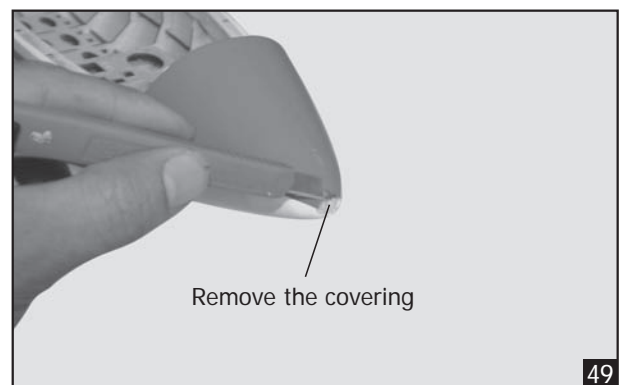
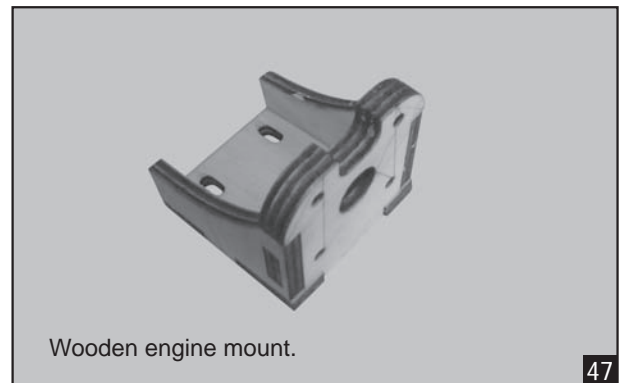

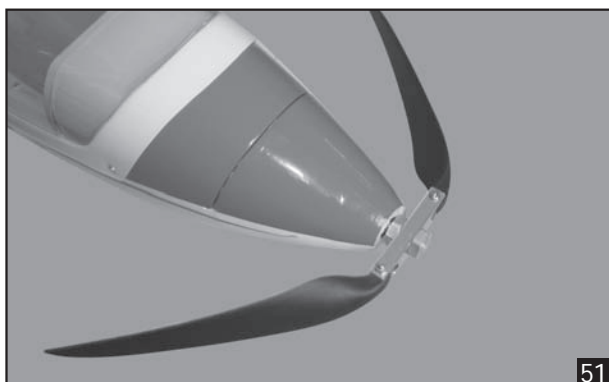
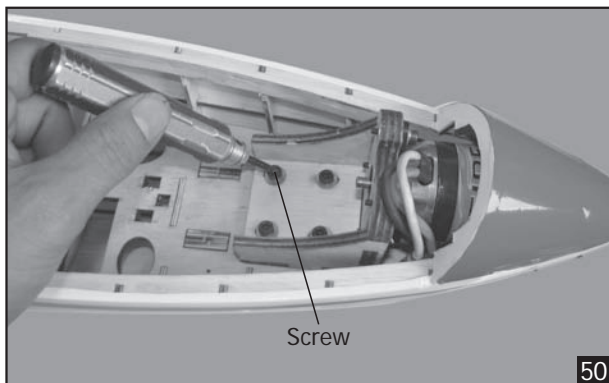

**RECOMMENDED MOTOR AND BATTERY SET UP**

- Motor: OS OMA – 3825-750 (Not included)
- Propeller: 12x8 ; 13x8 (not included)
- Lipo cell: 3-4 cells / 3200 – 4000mAh (not included)
- Esc: 50-80 A (not included)

- Glue the plastic cover to the fuselage.

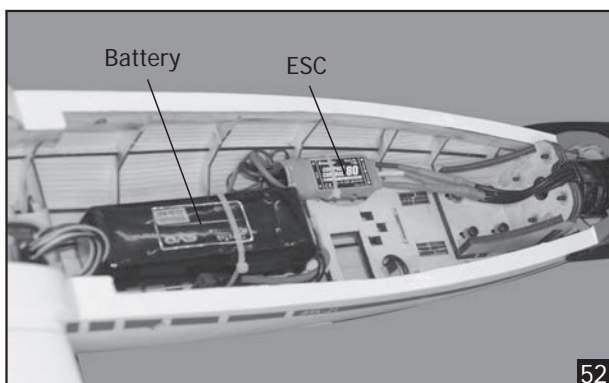
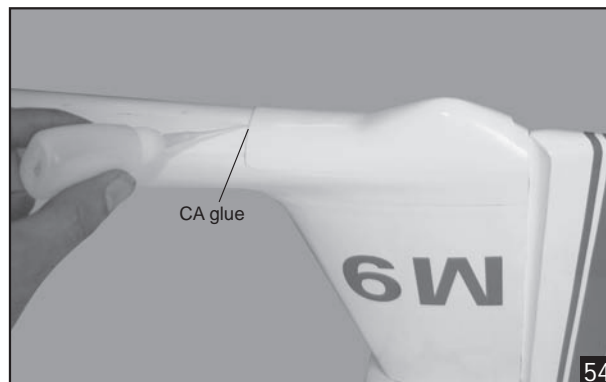

**BALANCING**

1. It is critical that your airplane be balanced correctly. Improper balance will cause your plane to lose control and crash.

THE CENTER OF GRAVITY IS LOCATED 75mm BACK FROM THE LEADING EDGE OF THE WING, AT THE FUSELAGE. This location is recommended for initial test flying and trimming. BALANCE A PLANE UPSIDE DOWN WITH THE FUEL TANK EMPTY.

2. Mount the wing to the fuselage. Using a couple of pieces of masking tape, place them on the top side of the wing 75mm back from the leading edge, at the fuselage sides.
3. Turn the airplane upside down. Place your fingers on the masking tape and carefully lift the plane .
4. If the nose of the plane falls, the plane is nose heavy. To correct this first move the battery pack further back in the fuselage. If this is not possible or does not correct it, stick small amounts of lead weight on the fuselage under the horizontal stabilizer. If the tail of the plane falls, the plane is tail heavy. To correct this, move the battery and receiver forward or if this is not possible, stick weight into the firewall. When balanced correctly, the airplane should sit level or slightly nose down when you lift it up with your fingers.

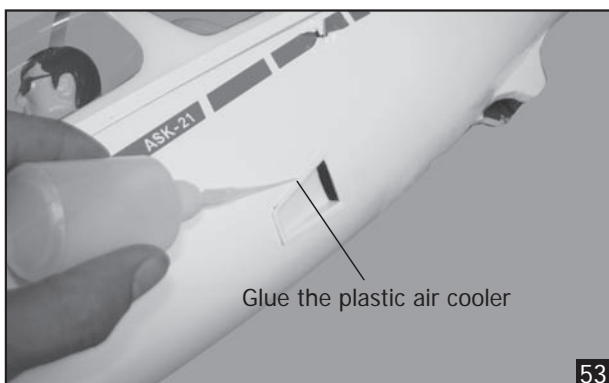

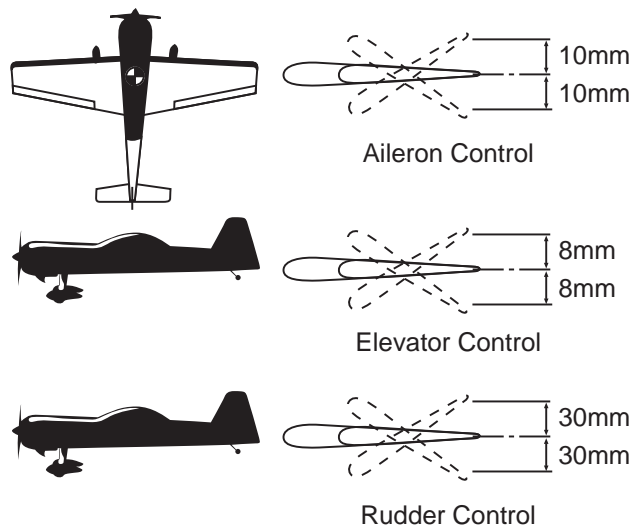
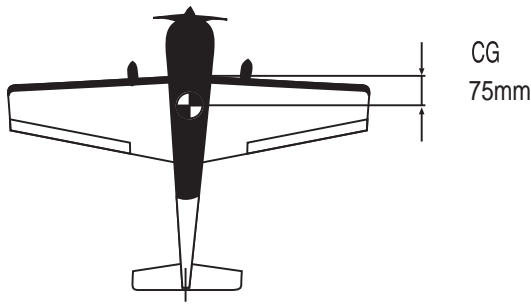

**LATERAL BALANCE**

**!** After you have balanced a plane on the C.G. You should laterally balance it. Doing this will help the airplane track straighter.

5. Turn the airplane upside down. Attach one loop of heavy string to the engine crankshaft and one to the tail wheel wire. With the wings level, carefully lift the airplane by the string. This may require two people to make it easier.
6. If one side of the wing fall, that side is heavier than the opposite. Add small amounts of lead weight to the bottom side of the lighter wing half's wing tip. Follow this procedure until the wing stays level when you lift the airplane.

**CONTROL THROWS**

1. We highly recommend setting up a plane using the control throws listed.
2. The control throws should be measured at the widest point of each control surface.
3. Check to be sure the control surfaces move in the correct directions.

Aileron	: 10mm up	10mm down
Elevator	: 8mm up	8mm down
Rudder	: 30mm right	30 mm left

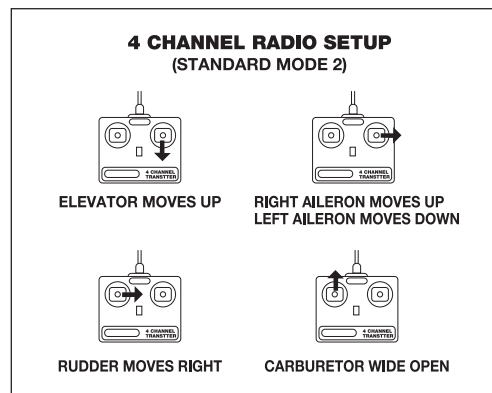

**FLIGHT PREPARATION**

**PRE FLIGHT CHECK**

1. Completely charge your transmitter and receiver batteries before your first day of flying.
2. Check every bolt and every glue joint in your plane to ensure that everything is tight and well bonded.
3. Double check the balance of the airplane.
4. Check the control surface.
5. Check the receiver antenna . It should be fully extended and not coiled up inside the fuselage.
6. Properly balance the propeller.

# I/C FLIGHT GUIDELINES

