

LASER 200



DESIGNED BY:

Giuseppe Tommasini

SUPER PNP

Quick Assembly Guide

Thank you for purchasing the Flex Innovations Laser 200 60E!

Flex Innovations airplanes are now shipping with digital manuals. This ensures that you always have the most up-to-date information, including any future modifications, upgrades or even future product generations. It also makes your assembly and flying experience as accurate and enjoyable as possible.

You can find the most updated version of the manual at the link shown below or simply by scanning the QR code with your phone. If you would like a printed version of the manual and did not order one with your airplane you can also find information on how to order one at the same location.

If you have experience assembling Flex Innovations Super PNP aircraft then this quick assembly guide is for you. Inside you will find general assembly sequence recommendations, radio setup details and everything you need pre-flight. This assembly guide is not comprehensive and assumes a certain level of familiarity and comfort with the process.

For full details on how to put together your Laser 200 60E, for any last minute updates, for additional details such as parts lists please follow the link or the QR code for the complete manual.



<https://www.flexinnovations.com/product/laser-200-60e/>

Introduction

Inspired by this full-scale champion, F3A and 3D World Champion Quique Somenzini designed the Laser 200 60E not only to pay homage to its full-scale counterpart by maintaining the Laser 200's iconic lines but also to replicate its championship-level performance. The Laser 200 60E is available in both day and night versions, as well as two incredible schemes: the retro 1980 World Championship tribute scheme and the modern Clint Sweet Designs "XA Scheme", ensuring you stand out at the airfield.

From its homage to the iconic lines of the Laser 200 to its championship-level prowess, this model stands as a testament to the spirit of innovation and excellence that defines Flex Innovations. Experience a new era in aerobatics with the Laser 200 60E—where history meets cutting-edge technology.

Completion Items

You will need the following to complete your Laser 200 60E:

- 3500-4200mAh 6S 22.2V 35C+ Li-Po (FPZB42006S40 recommended)
- Minimum 7 channel transmitter
- Serial capable receiver to match your transmitter, e.g. Spektrum 4651T or Futaba R2001SB. For a current list of compatible receivers visit: <https://wiki.flexinnovations.com/wiki/Aura>

General Tips for this Quick Assembly Guide

This guide will go through a recommended sequence of assembly, including most pertinent information for each step, but without any major details. It will include a small quantity of pictures wherever necessary to clarify or illustrate these steps.

This information should be enough to put the Laser 200 60E together but if you have any doubts please reference the full manual.

Note: Do not use thread locker when attaching plastic parts, the parts will soften and fail.

Note: If you have the night version of the Laser 200 60E we recommend that you dry assemble the airframe and test all the lights before bonding anything permanently in place.

Assembly Sequence

Main Landing Gear

The diagram to the right shows the orientation of the landing gear, note this when assembling and mounting.

1. Mount the main landing gear to the fuselage using four M3x15 screws and thread locker.
2. Mount the main gear shafts and tires to the landing gear using a M4 washer, an M4 nut and thread locker.
3. Take apart the wheel pants. Slide the inside wheel pants down over the wheel and shaft and mount them to the landing gear using M3x10 screws and thread locker.
4. Secure the outside of the wheel pants to the inside using two M3x12 self tapping screws per side.

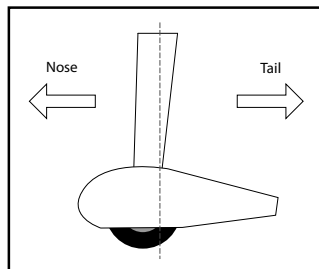

Vertical Fin and Tail Wheel

1. Dry fit the vertical fin to the fuselage.
2. Once everything fits correctly, clean all surfaces with rubbing alcohol before bonding.
3. Bond the vertical fin assembly to the fuselage using medium CA or 15-minute epoxy adhesive. Ensure that you get adhesive on all the mating surfaces.
4. Clamp the vertical fin assembly in place while the adhesive dries.
5. Secure the bottom of the rudder using an M3x10 self tapping screw, don't over-tighten, the rudder must be free to rotate.
6. Insert the tail wheel into the slot in the bottom of the rudder.
7. Secure the retaining plate to the rudder fin using three M3x10 self tapping screws.

Assembly Sequence Continued

Horizontal Stabilizer

1. Insert and roughly center the carbon fiber horizontal stabilizer tube in the fuselage.
2. Insert both halves of the horizontal stabilizer onto the tube. Ensure that the control horn faces the bottom of the fuselage and that the elevator jointer tabs line up properly.
3. If you have the night version, connect the LED power connectors.
4. Once both halves of the horizontal stabilizer are seated in place secure them each using two M3x8 self tapping screws on the underside of the stabilizer.

Rudder and Elevator Linkages

Install the rudder and elevator linkages now but after setup you may need to re-center servo arms and ensure that the pushrods are the correct length to center the control surfaces.

1. Using M3x6 screws, install the servo arms on the servos so that they are perpendicular to the servos and face towards the ground. Once radio setup is complete, remove these screws and re-install them with thread locker.
2. Install the linkages between the servos and the corresponding control surface using the following hardware sequence: M2x10 Machine Screw → M2 Washer → Servo Arm or Control Horn → M2 Lock Nut.
3. The following diagrams show the positions of the linkages:

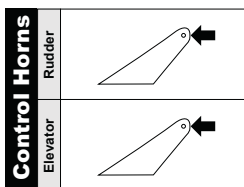
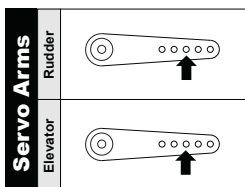

Note: Do not use thread locker on the bolts holding the push rods to the servos or the control horns!
Using thread locker will weaken the plastic, void your warranty and cause your airplane to crash!

Wing Installation

1. Remove the hatch from the fuselage.
2. Insert and roughly center the carbon fiber wing tube in the fuselage.
3. Slide the left and right wing panels onto the tube. Ensure the servos orient to the bottom of the fuselage.
4. Connect the aileron servos to the corresponding ports in the Aura 8 (see page 5 for port assignments).
5. If you have the night version, connect the LED power connectors.
6. Seat the wings completely in the wing saddles and secure the wings using the thumb screws through the aluminum tabs.
7. Screw on the side force generators using two M5X35 nylon screws each. **Do not over tighten.**

Note: Do not install the propeller on the airplane for now, this will be installed after radio setup and testing is complete.

Radio Configuration

The following shows the pre-configured Aura flight modes in the Laser 200 60E.

Laser 200 60E Aura Profile

Flight Mode 1: Sport (Gyro On)

- For general flight
- Rates are low and expos tuned for general flight
- Gyro is set to low

Flight Mode 2: Extreme Aerobatics (Gyro On)

- For more advanced aerobatics like tumbles and spins while at high airspeeds
- Rates are highest and expos are tuned for comfortable flight
- Gyro is set to low

Flight Mode 3: Slow Speed 3D (Gyro On)

- For slow speed, 3D flight
- Rates are highest and expos are tuned for comfortable flight
- Gyro is set to its highest setting and may oscillate in high speed flight under certain conditions

The following table shows the radio configuration required for the Laser 200 60E:

	Spektrum, Futaba, JR & Graupner	FrSky	Jeti (EX-Bus)
Wing/Tail Type	1 Aileron, 1 Elevator, 1 Rudder	1 Aileron, 1 Elevator, 1 Rudder	1 Aileron, 1 Elevator, 1 Rudder
End Points (Travel Adjust or ATV)	Ail/Ele/Rud – 125%	Ail/Ele/Rud – 100%	Aileron/Ele/Rud – 100%
	Thro/CH5/CH6 – 100%	Thro/CH5/CH6 – 84%	Thro/CH5/CH6 – 80%
Reversing	Not Allowed		
Sub-Trim	Verify at Zero, NOT ALLOWED		
Trim Levers	Verify at Zero		
CH5 (Gear) – Flight Mode	Assign to a 3 Position Switch		
CH6 (Aux 1) – LEDs On/Off ¹	Assign to a 2 Position Switch		
CH7 (Aux 2) – Gyro On/Off ²	Assign to a 2 Position Switch		
First Flight Timer	For your first flight, set to 4:00		

¹ This is only required to switch the LEDs On/Off via the transmitter. If the LED controller is unplugged from the receiver or Aura 8, the lights default in the ON position when powered.

² The default Aura program has Gyro On/Off disabled, see the full manual for instructions on using **Quick Set** to enable Gyro On/Off.

Connect your serial receiver to the Aura and bind it to your transmitter. Once this is complete proceed with final configuration.

For more details on compatible receivers, on connecting and binding different receivers, flight modes and radio configuration download the complete Laser 200 60E manual (link on the cover page) or visit the Aura Wiki at:

<https://wiki.flexinnovations.com/wiki/Aura>

Aura Configuration

DEFAULT AURA CONNECTIONS

- S1 – Throttle
- S2 – Left Aileron
- S3 – Right Aileron
- S4 – Elevator
- S5 – Rudder
- S6 – LED Controller

Port B – Serial Receiver Input

Mini Port A&B – Remote Receiver Inputs

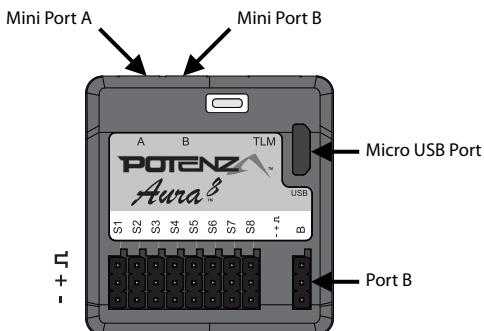

Aura 8 Auto-Detect

Once your receiver is bound, powered, and connected to the Aura, the Aura will begin the Auto-Detect process to learn what type of receiver you are using and set itself up for that specific system. Auto-Detect is indicated by a series of sweeping LEDs of various colors. After Auto-Detect is completed, verify that Aura is on and receiving data from your receiver by looking at the LEDs on the Aura.

Ready-To-Fly:

Solid Orange LED: Aura On and Calibrated



Solid Green LED: Aura receiving Valid receiver data

Possible Errors:

Flashing Orange LED: Aura Moved During Power Up



No Green LED: Aura NOT receiving receiver data

Connecting Battery and Arming ESC

1. Turn on the transmitter. Lower the throttle stick AND throttle trim to their lowest settings.
2. Ensure the aileron, elevator and rudder gimbals are centered.
3. With the airplane on a solid surface, connect the battery to the ESC and wait. The ESC will make the motor emit a series of audible tones during its initialization process.
4. The ESC will make the motor emit a short, final tone sequence indicating that the ESC is now armed and that the motor will spin in response to throttle stick movement.

ESC Throttle Calibration

In order to map the full range of the ESC output to your throttle stick motion you will have to preform an ESC throttle calibration. **NOTE: Execute ESC throttle calibration with the propeller and spinner removed.**

1. Power on your transmitter, DISABLE any throttle hold or throttle kill switches, **completely lower the throttle trim** and set the stick to full throttle.
2. Connect the flight pack to your Laser 200 60E.
3. Listen for the tones coming from the ESC through the motor, after about 2 seconds you should hear two tones.
4. Pull your throttle stick back to idle.
5. Listen for the ESC arming tones from the motor.
6. Unplug the flight battery to complete calibration.

Note: After throttle calibration is complete it is necessary to reset the failsafe (see your radio documentation, this may require a re-bind).

Final Radio Setup

Take this moment to finalize the position of the servo arms and pushrod lengths on your Elevators and Rudder and ensure that the motor is spinning in the correct direction (clockwise when viewed from the cockpit). Make any final control surface adjustments as necessary either mechanically or in the Aura, do not use trim or sub-trim.

Control Direction Test

Refer to the chart below to determine the proper control surface directions.

If controls are reversed, DO NOT REVERSE CONTROLS IN YOUR TRANSMITTER OR IN THE AURA CONFIG TOOL. Email us at support@flexinnovations.com for corrective action. Note that BOTH the Transmitter Control Direction Test AND the Flight Controller Sensor Direction Test MUST BE PASSED! IF EITHER ONE DOES NOT PASS, DO NOT FLY!

NOTE: There is pre-configured rudder to aileron and rudder to elevator mixing programmed into the Aura. Simultaneous movement of these control surfaces with rudder input is intentional and completely **NORMAL**.

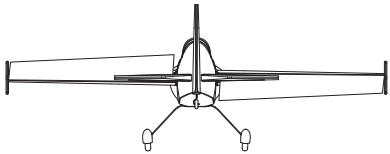
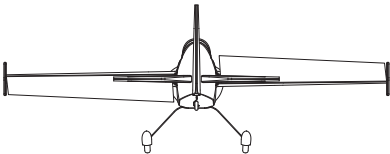
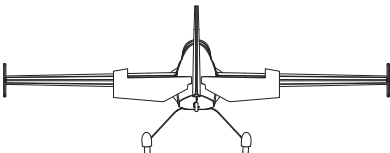
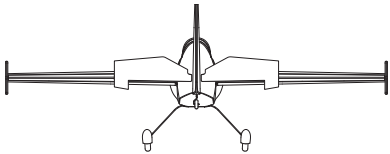
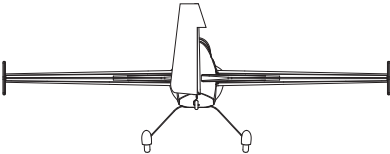
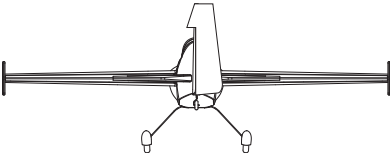
	Transmitter Command	Proper Control Surface Deflection
AILERON	Stick Left	
	Stick Right	
ELEVATOR	Stick Forward	
	Stick Aft	
RUDDER	Stick Left	
	Stick Right	

Aura Sensor Direction Test

Perform a test of the gyro system to verify the corrections made for a given movement are correct. **If any of the tests do not result in the correct reaction from the airplane's gyro system, DO NOT FLY THE AIRPLANE, and contact us via email at support@flexinnovations.com**

The flight control system activates with RF broadcast. Perform these tests in Flight Mode 3 (higher gain) for better visibility and then in the remaining Flight Modes. Control surface deflections are exaggerated in the pictures below for clarity. Please note that the control surfaces will move ONLY while the aircraft is being ROTATED.

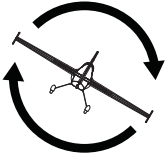
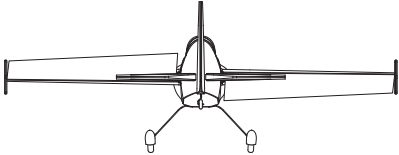
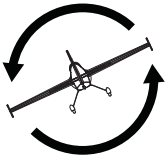
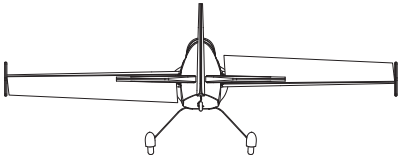
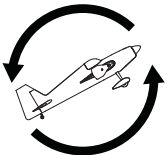
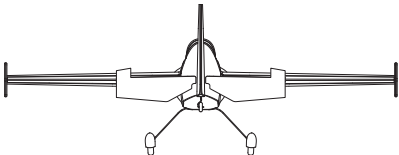
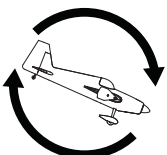
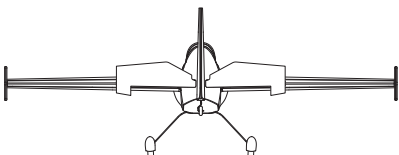
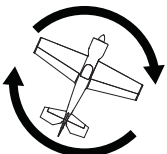
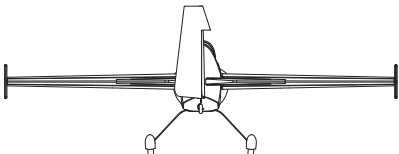
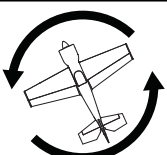
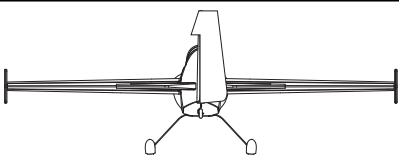
	Aircraft Movement	Proper Control Surface Deflection
AILERON		
		
ELEVATOR		
		
RUDDER		
		

Completion and Flight Readiness

Once your radio and Aura 8 configuration is complete there are only a few steps left to get your Laser 200 60E in the air:

1. Mount the propeller to the motor using the provided washer and nut.
2. Install the spinner to the prop adapter using the provided M3 X 10 screw.
3. Move the battery back and forth as necessary to achieve the desired CG (shown below).

Center of Gravity Verification

The center of gravity (CG) location for your aircraft is located between the two locations provided, adjust within that range to suit your flying style.

The recommended CG is located 5-7/8 inches (150mm) FORWARD of the trailing edge of the wing at the wing tip.

The acceptable range for the CG is between 6-1/8 and 5-13/16 inches (155mm and 148mm) FORWARD of the trailing edge of the wing at the wing tip.

First Flight and Quick Trim

We recommend that you fly the maiden flight using **Flight Mode 1** (Sport Mode). Trim the airplane until you achieve straight and level flight. Once you land execute the below Quick Trim procedure ensuring that you keep Flight Mode 1 selected.

1. Power off the Laser 200 60E. Insert a bind plug into Aura Port S3 (you will need to remove the servo lead that is currently in S3). Check that the transmitter is powered on and re-power the Aura to enter Quick Trim.
2. Wait 5 seconds for the Aura to completely initialize. Confirm Quick Trim mode is active by checking the Blue LED is slowly flashing.
3. Remove the bind plug to save your trim settings, the Blue LED will now flash quickly indicating the new trim values have been stored successfully. Power off the Laser 200 60E and re-install the servo into port S3.
4. Center all control surface trims on the transmitter.
5. Re-power the Laser 200 60E, the control surfaces should be unchanged as the new trims have been applied.

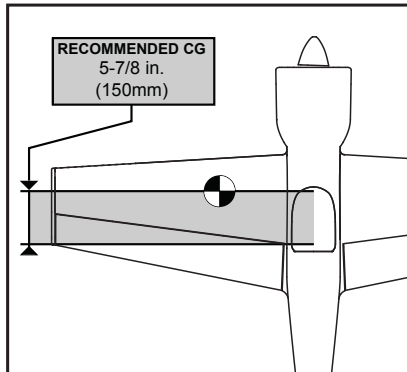

Enjoy your Flex Innovations Laser 200 60E!



© 2024 Flex Innovations, LLC. All rights reserved.
Potenza™ is a trademarks of Flex Innovations LLC
DSM®, DSM2™, and DSMX™ are trademarks of Horizon Hobby, Inc.
Futaba is a registered trademark of Futaba Denshi Kogyo Kaishiki Kaisha Corporation of Japan.
Jeti, UDI, and Jeti Model are trademarks or registered trademarks of Jelen, Ing. Stanislav of Czech Republic
HoTT is a registered trademark of SJ, Inc.