

RV-8 60E G2



DESIGNED BY:

Giuseppe Tompazini

SUPER PNP

Quick Assembly Guide

Thank you for purchasing the Flex Innovations RV-8 60E G2!

Flex Innovations airplanes are now shipping with digital manuals. This ensures that you always have the most up-to-date information, including any future modifications, upgrades or even future product generations. It also makes your assembly and flying experience as accurate and enjoyable as possible.

You can find the most updated version of the manual at the link shown below or simply by scanning the QR code with your phone. If you would like a printed version of the manual and did not order one with your airplane you can also find information on how to order one at the same location.

If you have experience assembling Flex Innovations Super PNP aircraft then this quick assembly guide is for you. Inside you will find general assembly sequence recommendations, radio setup details and everything you need pre-flight. This assembly guide is not comprehensive and assumes a certain level of familiarity and comfort with the process.

For full details on how to put together your RV-8 60E G2, for any last minute updates, for additional details such as parts lists please follow the link or the QR code for the complete manual.



<https://www.flexinnovations.com/product/rv-8-60e-g2-super-pnp/>

Introduction

The Flex Innovations RV-8 60E G2 is a massive, yet lightweight airframe that offers an incredibly wide flight envelope. From beginners to experts, the RV-8 has something to offer everyone. Beautiful scale lines, clear canopy with pilot figure and a beautiful color scheme deliver a true-to-scale presence in the air and on the ground. With multiple improvements over the original, generation 2 of the RV-8 60E offers better performance, better reliability and better fit and finish!

Completion Items

You will need the following to complete your RV-8 60E G2:

- 4200-6200mAh 6S 22.2V 35C+ Li-Po (FPZB52006540 recommended)
- Minimum 8 channel transmitter
- Serial capable receiver to match your transmitter, e.g. Spektrum 4651T or Futaba R2001SB. For a current list of compatible receivers visit: <https://wiki.flexinnovations.com/wiki/Aura>

General Tips for this Quick Assembly Guide

This guide will go through a recommended sequence of assembly, including most pertinent information for each step, but without any major details. It will include a small quantity of pictures wherever necessary to clarify or illustrate these steps.

This information should be enough to put the RV-8 60E G2 together but if you have any doubts please reference the full manual.

Note: Do not use thread locker when attaching plastic parts, the parts will soften and fail.

Note: If you have the night version of the RV-8 60E G2 we recommend that you dry assemble the airframe and test all the lights before bonding anything permanently in place.

Assembly Sequence

Landing Gear

The diagram to the right shows the orientation of the landing gear, note this when assembling and mounting.

1. Mount the main landing gear to the fuselage using four M3x20 screws and thread locker.
2. Mount the inside wheel pants and retaining plates to the main landing gear using M3x12 self tapping screws.
3. Mount the main gear shafts to the landing gear using a washer, an M5 nut and thread locker.
4. Secure the outside of the wheel pants to the inside using five M3x8 self tapping screws per side.
5. Insert the tail wheel into the slot in the bottom of the rudder (orientation showing in picture to the right).
6. Secure the retaining plate to the rudder fin using three M3x7 self tapping screws.

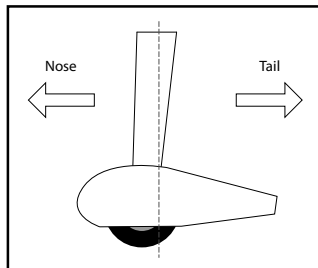

Vertical Fin

The vertical fin assembly uses the short carbon fiber rod for reinforcement.

1. Dry fit the vertical fin and reinforcement rod to the fuselage.
2. Once everything fits correctly, remove the carbon fiber rod and lightly scuff it with 220 grit sandpaper to aid in adhesion. Clean all surfaces with rubbing alcohol before bonding.
3. Bond the vertical fin assembly to the fuselage using 30-minute epoxy adhesive. Ensure that you get adhesive not only on all the mating surfaces but also on the carbon fiber rod.
4. Clamp the vertical fin assembly in place while the adhesive dries. **Note: Do not apply tape directly to any painted part as this will strip the paint off the part.**

Assembly Sequence Continued

Horizontal Stabilizer

1. Insert and roughly center the carbon fiber horizontal stabilizer tube in the fuselage.
2. Insert both halves of the horizontal stabilizer onto the tube. Ensure that the control horn faces the bottom of the fuselage and that the elevator jointer tabs line up properly.
3. If you have the night version, connect the LED power connectors.
4. Once both halves of the horizontal stabilizer are seated in place secure them each using two M3x8 self tapping screws.

Rudder and Elevator Linkages

Install the rudder and elevator linkages now but after setup you may need to re-center servo arms and ensure that the pushrods are the correct length to center the control surfaces.

1. Using M3x6 screws, install the servo arms on the servos so that they are perpendicular to the servos and face towards the ground. Once radio setup is complete, remove these screws and re-install them with thread locker.
2. Install the linkages between the servos and the corresponding control surface using the following hardware sequence: M2x10 Machine Screw → M2 Washer → Servo Arm or Control Horn → M2 Lock Nut.
3. The following diagrams show the positions of the linkages:

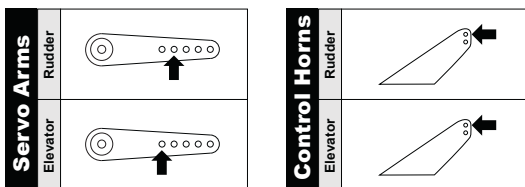

Note: Do not use thread locker on the bolts holding the push rods to the servos or the control horns!
Using thread locker will weaken the plastic, void your warranty and cause your airplane to crash!

Wing Installation

1. Remove the hatch from the fuselage.
2. Insert and roughly center the carbon fiber wing tube in the fuselage.
3. Slide the left and right wing panels onto the tube. Ensure the servos orient to the bottom of the fuselage.
4. Connect the single wing connector from each wing panel to the corresponding connector on the fuselage.
5. If you have the night version, connect the LED power connectors.
6. Seat the wings completely in the wing saddles and secure the wings using the thumb screws through the aluminum tabs.

Exhaust Installation

1. Use medium CA to bond the scale exhaust pieces to the exhaust port on the bottom of the fuselage.

Motor and Cowling Installation

1. Install the prop adapter on the front of the motor using the provided socket head hex screws and thread locker.
2. Install the x-brace on the back of the motor using four M4x8 flat head screws and thread locker.
3. Mount the motor to the firewall using four M4x22 button head screws and thread locker.
4. Connect the three motor leads to the ESC leads in the fuselage (when you test the motor, if it spins in the wrong direction you can reverse the direction of rotation by swapping any two leads).
5. Install the cowling using two M3x8 screws through the cooling holes in the cowling.
6. **Note: Do not install the propeller on the airplane for now, this will be installed after radio setup and testing.**

Radio Configuration

The following shows the pre-configured Aura flight modes in the RV-8 60E G2.

RV-8 60E G2 Aura Profile

Flight Mode 1: Sport (Gyro On)

- For general flight
- Rates are low and expos tuned for general flight (no live wing).
- Gyro is set set to low

Flight Mode 2: Advanced (Gyro On)

- For more advanced aerobatics like tumbles and spins while at high airspeeds
- Rates are moderately high and expos are tuned for comfortable flight
- Flaps work in conjunction with ailerons for added roll authority (live wing).
- Gyro is set to low

Flight Mode 3: Slow Speed 3D (Gyro On)

- For slow speed, 3D flight
- Rates are highest and expos are tuned for comfortable flight
- Flaps work in conjunction with ailerons for added roll authority (live wing).
- Gyro is set to its highest setting and may oscillate in high speed flight under certain conditions.

The following table shows the radio configuration required for the RV-8 60# G2:

	Spektrum, Futaba, JR & Graupner	FrSky	Jeti (EX-Bus)
Wing/Tail Type	1 Aileron, 1 Elevator, 1 Rudder	1 Aileron, 1 Elevator, 1 Rudder	1 Aileron, 1 Elevator, 1 Rudder
End Points (Travel Adjust or ATV)	Ail/Ele/Rud – 125%	Ail/Ele/Rud – 100%	Aileron/Ele/Rud – 100%
	Thro/CH5/CH6 – 100%	Thro/CH5/CH6 – 84%	Thro/CH5/CH6 – 80%
Reversing	Not Allowed		
Sub-Trim	Verify at Zero, NOT ALLOWED		
Trim Levers	Verify at Zero		
CH5 (Gear) – Flight Mode	Assign to a 3 Position Switch		
CH6 (Aux 1) – Flaps	Assign to a 3 Position Switch (Do NOT use Transmitter Flap System)		
CH7 (Aux 2) – Gyro On/Off*	Assign to a 2 Position Switch		
CH8 (Aux 3) – Crow*	Assign to a 2 Position Switch		
First Flight Timer	For your first flight, set to 5:30		

* The default Aura program has Gyro On/Off and Crow disabled, see the full manual for instructions on using **Quick Set** to enable Gyro On/Off and Crow.

Connect your serial receiver to the Aura and bind it to your transmitter. Once this is complete proceed with final configuration.

For more details on compatible receivers, on connecting and binding different receivers, flight modes and radio configuration download the complete RV-8 60E G2 manual (link on the cover page) or visit the Aura Wiki at: <https://wiki.flexinnovations.com/wiki/Aura>

Aura Configuration

DEFAULT AURA CONNECTIONS

- S1 – Throttle
- S2 – Left Aileron
- S3 – Right Aileron
- S4 – Elevator
- S5 – Rudder
- S6 – Left Flap
- S7 – Right Flap
- S8 – Water Rudder (optional, with floats)

Port B – Serial Receiver Input

Mini Port A&B – Remote Receiver Inputs

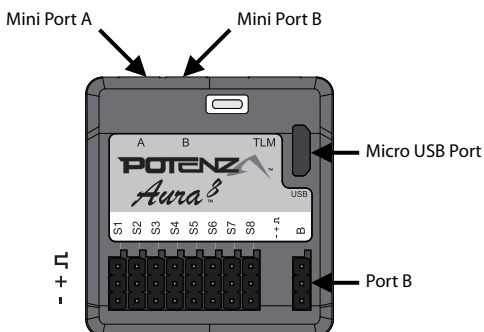

Aura 8 Auto-Detect

Once your receiver is bound, powered, and connected to the Aura, the Aura will begin the Auto-Detect process to learn what type of receiver you are using and set itself up for that specific system. Auto-Detect is indicated by a series of sweeping LEDs of various colors. After Auto-Detect is completed, verify that Aura is on and receiving data from your receiver by looking at the LEDs on the Aura.

Ready-To-Fly:

Solid Orange LED: Aura On and Calibrated



Solid Green LED: Aura receiving Valid receiver data

Possible Errors:

Flashing Orange LED: Aura Moved During Power Up



No Green LED: Aura NOT receiving receiver data

Connecting Battery and Arming ESC

- Turn on the transmitter. Lower the throttle stick AND throttle trim to their lowest settings.
- Ensure the aileron, elevator and rudder gimbals are centered.
- With the airplane on a solid surface, connect the battery to the ESC and wait. The ESC will make the motor emit a series of audible tones during its initialization process.
- The ESC will make the motor emit a short, final tone sequence indicating that the ESC is now armed and that the motor will spin in response to throttle stick movement.

ESC Throttle Calibration

In order to map the full range of the ESC output to your throttle stick motion you will have to perform an ESC throttle calibration. **NOTE: Execute ESC throttle calibration with the propeller and spinner removed.**

- Power on your transmitter, DISABLE any throttle hold or throttle kill switches, **completely lower the throttle trim** and set the stick to full throttle.
- Connect the flight pack to your RV-8 60E G2.
- Listen for the tones coming from the ESC through the motor, after about 2 seconds you should hear two tones.
- Pull your throttle stick back to idle.
- Listen for the ESC arming tones from the motor.
- Unplug the flight battery to complete calibration.

Note: After throttle calibration is complete it is necessary to reset the failsafe (see your radio documentation, this may require a re-bind).

Final Radio Setup

Take this moment to finalize the position of the servo arms and pushrod lengths on your Elevators and Rudder and ensure that the motor is spinning in the correct direction (clockwise when viewed from the cockpit). Make any final control surface adjustments as necessary either mechanically or in the Aura, do not use trim or sub-trim.



Control Direction Test

Refer to the chart below to determine the proper control surface directions.

If controls are reversed, DO NOT REVERSE CONTROLS IN YOUR TRANSMITTER OR IN THE AURA CONFIG TOOL. Email us at support@flexinnovations.com for corrective action. Note that BOTH the Transmitter Control Direction Test AND the Flight Controller Sensor Direction Test MUST BE PASSED! IF EITHER ONE DOES NOT PASS, DO NOT FLY!

NOTE: There is pre-configured rudder to aileron and rudder to elevator mixing programmed into the Aura. Simultaneous movement of these control surfaces with rudder input is intentional and completely **NORMAL**.



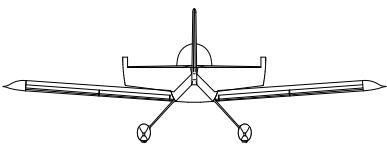
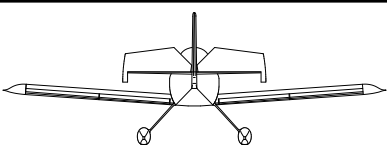
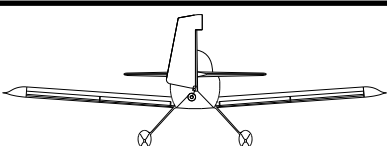
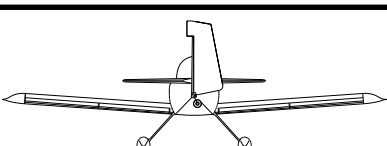

Additionally: Aura has a built-in flap system that moves the flaps at a slower speed. There is also flap to elevator mixing configured in the Aura Flap System. This speed and mixing is intentional and completely **NORMAL**.

	Transmitter Command	Proper Control Surface Deflection
AILERON	Stick Left	
	Stick Right	
ELEVATOR	Stick Forward	
	Stick Aft	
RUDDER	Stick Left	
	Stick Right	

Aura Sensor Direction Test

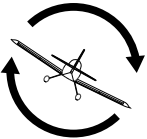
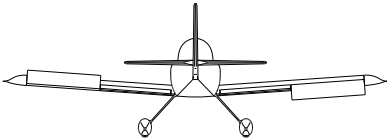
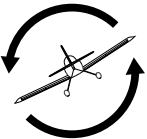
Perform a test of the gyro system to verify the corrections made for a given movement are correct. **If any of the tests do not result in the correct reaction from the airplane's gyro system, DO NOT FLY THE AIRPLANE, and contact us via email at support@flexinnovations.com**

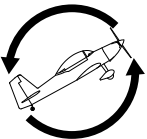
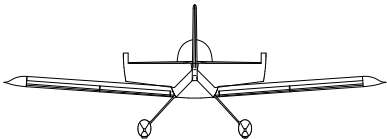
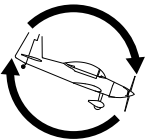
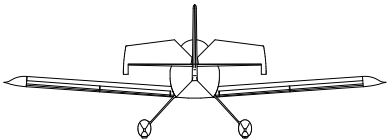
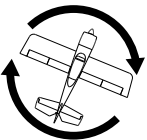
The flight control system activates with RF broadcast. Perform these tests in Flight Mode 3 (higher gain) for better visibility and then in the remaining Flight Modes. Control surface deflections are exaggerated in the pictures below for clarity. Please note that the control surfaces will move **ONLY** while the aircraft is being **ROTATED**.

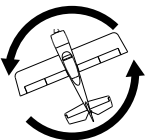
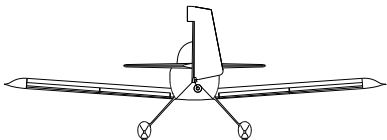
	Aircraft Movement	Proper Control Surface Deflection
AILERON		
		
ELEVATOR		
		
RUDDER		
		

Completion and Flight Readiness

Once your radio and Aura 8 configuration is complete there are only a few steps left to get your RV-8 60E G2 in the air:

1. Mount the propeller to the motor using the provided washer and nut.
2. Install the spinner to the prop adapter using the provided M3 X 10 screw.
3. Move the battery back and forth as necessary to achieve the desired CG (shown below).

Center of Gravity Verification

The center of gravity (CG) location for your aircraft is located in two locations depending on the flying style you wish to fly.

For general sport flying, the CG is located 11-7/32 inches (285mm) FORWARD of the trailing edge of the wing.

For more aerobatic capability, the CG is located 10-13/16 inches (275mm) FORWARD of the trailing edge of the wing.

First Flight and Quick Trim

We recommend that you fly the maiden flight using Flight Mode 2. Trim the airplane until you achieve straight and level flight. Once you land execute the below Quick Trim procedure ensuring that you keep Flight Mode 2 selected.

1. Power off the RV-8 60E G2. Insert a bind plug into Aura Port S3 (you will need to remove the servo lead that is currently in S3). Check that the transmitter is powered on and re-power the Aura to enter Quick Trim.
2. Wait 5 seconds for the Aura to completely initialize. Confirm Quick Trim mode is active by checking the Blue LED is slowly flashing.
3. Remove the bind plug to save your trim settings, the Blue LED will now flash quickly indicating the new trim values have been stored successfully. Power off the RV-8 60E G2 and re-install the servo into port S3.
4. Center all control surface trims on the transmitter.
5. Re-power the RV-8 60E G2, the control surfaces should be unchanged as the new trims have been applied.

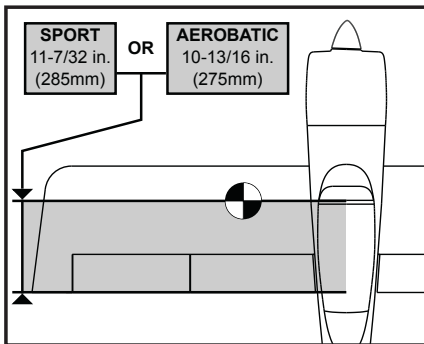

Enjoy your Flex Innovations RV-8 60E G2!



© 2023 Flex Innovations, LLC. All rights reserved.
Potenza™ is a trademarks of Flex Innovations LLC
DSM®, DSM2™, and DSMX™ are trademarks of Horizon Hobby, Inc.
Futaba is a registered trademark of Futaba Denshi Kogyo Kaishiki Kaisha Corporation of Japan.
Jeti, UDI, and Jeti Model are trademarks or registered trademarks of Jelen, Ing. Stanislav of Czech Republic
HoTT is a registered trademark of SJ, Inc.