

DESIGNED BY:

Giuseppe Tompagnani

Twin Otter



SUPER PNP

Quick Assembly Guide

Thank you for purchasing the Flex Innovations Twin Otter 80E!

Flex Innovations airplanes are now shipping with digital manuals. This ensures that you always have the most up-to-date information, including any future modifications, upgrades or even future product generations. It also makes your assembly and flying experience as accurate and enjoyable as possible.

You can find the most updated version of the manual at the link shown below or simply by scanning the QR code with your phone. If you would like a printed version of the manual and did not order one with your airplane you can also find information on how to order one at the same location.

If you have experience assembling Flex Innovations Super PNP aircraft then this quick assembly guide is for you. Inside you will find general assembly sequence recommendations, radio setup details and everything you need pre-flight. This assembly guide is not comprehensive and assumes a certain level of familiarity and comfort with the process.

For full details on how to put together your Twin Otter 80E, for any last minute updates, for additional details such as parts lists please follow the link or the QR code for the complete manual.



<https://www.flexinnovations.com/product/twin-otter-80e-super-pnp/>

Introduction

The Flex Innovations Twin Otter 80E offers something incredible for everyone. At first glance, it is a forgiving general twin engine aviation aircraft with rough field capabilities but take a deeper look into the heart of the Twin Otter, and you'll find its expansive capability. From wild 3D aerobatics to gentle touch and goes on land or water, this incredible aircraft offers a perfectly balanced airframe for all flying styles.

Completion Items

You will need the following to complete your Twin Otter 80E:

- 5200-6200mAh 6S 22.2V 40C+ Li-Po (6200mAh, FPZB62006540 recommended)
- Minimum 8 channel transmitter
- Serial capable receiver to match your transmitter, e.g. Spektrum 4651T or Futaba R2001SB. For a current list of compatible receivers visit: <https://wiki.flexinnovations.com/wiki/Aura>

General Tips for this Quick Assembly Guide

This guide will go through a recommended sequence of assembly, including most pertinent information for each step, but without any major details. It will include a small quantity of pictures wherever necessary to clarify or illustrate these steps.

This information should be enough to put the Twin Otter 80E together but if you have any doubts please download and reference the full manual.

Note: Do not use thread locker when attaching plastic parts, the parts will soften and fail.

Note: If you have the night version of the Twin Otter 80E we recommend that you dry assemble the airframe and test all the lights before bonding anything permanently in place.

Assembly Sequence

Landing Gear

Main Gear

1. Insert the wire landing gear into the slot in the fuselage. Insert the landing gear mount cover and secure using four M3x12mm self tapping screws.
2. Mount the wheels to the end of the landing gear with a wheel collet on each side of each wheel. Use thread locker on all the set screws.
3. Glue the foam fairings to the landing gear wire leaving a 1-2mm gap to the fuselage to allow for landing gear wire movement. We recommend using 15 minute epoxy.

Nose gear

4. Bond the nose gear tray to the fuselage using 30 minute epoxy
5. Mount the wheel to the end of the nose gear strut with a wheel collet on each side of the wheel. Use thread locker on all the set screws.
6. Install the nose gear strut to the airplane with a wheel collet in the middle of each of the mounts. The steering arm goes on top of the assembly. Use thread locker on all set screws. View picture to the right for assembly details.
7. Install the servo arm and push-rod after the airplane is powered on. Connect the servo lead to the Y-harness on port S8 of the Aura (rudder).

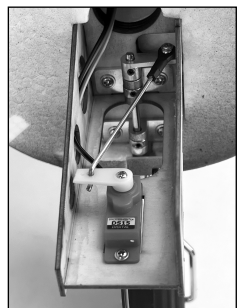

Tail

The tail assembly uses the short carbon fiber rod for reinforcement.

1. Dry fit the tail assembly and reinforcement rod to the fuselage.
2. Once everything fits correctly, remove the carbon fiber rod and lightly scuff it with 220 grit sandpaper to aid in adhesion. Clean all surfaces with rubbing alcohol before bonding.
3. If you have the night version first connect the LEDs. Bond the tail assembly to the fuselage using 30 minute epoxy. Ensure that you get adhesive on all the mating surfaces as well as both ends of the carbon fiber rod.
4. Insert the horizontal stab tube and the wing tube into the airplane, ensure that they are parallel before taping the tail section to the fuselage, this step is critical or the airplane will not end up straight.
5. Tape the assembly in place while the adhesive dries. **Note: Do not apply tape directly to any painted part as this will strip the paint off the part, place the tape only on the white areas.**

Assembly Sequence Continued

Horizontal Stabilizer

1. Insert and roughly center the carbon fiber horizontal stabilizer tube in the fuselage.
2. Insert both halves of the horizontal stabilizer onto the tube. Ensure that the control horn faces the bottom of the fuselage and that the elevator jointer tabs line up properly.
3. If you have the night version, connect the LED power connectors.
4. Once both halves of the horizontal stabilizer are seated in place secure them using four M3x8mm self tapping screws.

Rudder and Elevator Linkages

Install the rudder and elevator linkages now, but after setup you may need to re-center servo arms and ensure that the pushrods are the correct length to center the control surfaces. Always use FM1 when adjusting linkages.

1. Using M3x6mm screws, install the servo arms on the servos so that they are perpendicular to the servos and face towards the top of the airplane for the elevator and towards the ground for the rudder. Once radio setup is complete, remove these screws and re-install them with thread locker.
2. Install the linkages between the servos and the control surfaces using the following hardware sequence: M2x10mm Machine Screw → M2 Washer → Ball Link → Servo Arm or Control Horn → M2 Lock Nut.
3. The following diagram shows the positions of the linkages:

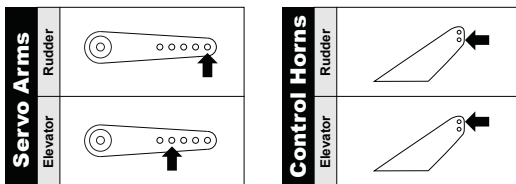

Note: Do not use thread locker on the bolts holding the push rods to the servos or the control horns!

Using thread locker will weaken the plastic, void your warranty and cause your airplane to crash!

Motor Installation

1. Install the prop adapters on the front of the motors using the provided socket head hex screws and thread locker.
2. Install the x-braces on the back of the motors using four M4x6mm flat head screws and thread locker.
3. Mount the motors to the nacelles using four M3x22mm button head screws and thread locker.
4. Temporarily remove the ESC covers and connect the three motor leads to the ESC leads inside the nacelles (when you test the motors, if they spin in the wrong direction you can reverse the direction of rotation by swapping any two leads).
5. **Note: Do not install the motor cowlings or the propellers at this point, these will be installed after radio setup and testing is complete.**

Wing Installation

1. Remove the hatch from the fuselage.
2. Install and secure the wing struts on the nacelles using a pin keeper.
3. Insert and roughly center the carbon fiber wing tube in the fuselage.
4. Slide the left and right wing panels onto the tube. Ensure the servos orient to the bottom of the fuselage.
5. Connect the single wing connector from each wing panel to the provided wing harnesses and connect the wing harnesses to the Aura as specified on page 5 of this guide.
6. Run the motor power lead (with the EC3 connector) into the fuselage and connect each wing to one end of the provided power lead Y-harness (2 EC3 connectors and 1 EC5 connector).
7. If you have the night version, connect the LED power connectors.
8. Seat the wings completely in the wing saddles and secure the wings using the thumb screws through the aluminum tabs. Before flight tighten the screws using a Phillips screwdriver.
9. Fasten the wing struts to the fuselage using the retaining pins and pin keepers.

Radio Configuration

The following shows the pre-configured Aura flight modes in the Twin Otter 80E.

Twin Otter 80E Aura Profile

Flight Mode 1: Sport (Gyro Off)

- For safety only.
- Rates and Expos are tuned for general flying.
- Gyro is set to off.

Flight Mode 2: Sport (Gyro On)

- For sport flying.
- Rates and expos are tuned for sport flying.
- Gyro is set to low.

Flight Mode 3: Advanced (Gyro On)

- For advanced aerobatic flight.
- Rates are highest and expos are tuned for 3D flight.
- Differential thrust is used (if enabled via switch).
- Gyro is set to moderately high.

In FM2 and FM3 the flaps are coupled with the ailerons for maximum roll rate and authority.

The following table shows the radio configuration required for the Twin Otter 80E:

	Spektrum, Futaba, JR & Graupner	FrSky	Jeti (EX-Bus)
Wing/Tail Type	1 Aileron, 1 Elevator, 1 Rudder	1 Aileron, 1 Elevator, 1 Rudder	1 Aileron, 1 Elevator, 1 Rudder
End Points (Travel Adjust or ATV)	Ail/Ele/Rud – 125%	Ail/Ele/Rud – 100%	Aileron/Ele/Rud – 100%
	Thro/CH5/CH6 – 100%	Thro/CH5/CH6 – 84%	Thro/CH5/CH6 – 80%
Reversing	Not Allowed		
Sub-Trim	Verify at Zero, NOT ALLOWED		
Trim Levers	Verify at Zero		
CH5 (Gear) – Flight Mode	Assign to a 3 Position Switch		
CH6 (Aux 1) – Flaps	Assign to a 3 Position Switch (Do NOT use Transmitter Flap System)		
CH7 (Aux 2) – Differential Thrust On/Off	Assign to a 2 Position Switch (We recommend that you use the same switch as you use for throttle cut)		
CH8(Aux 3) – Crow*	Assign to a 2 Position Switch		
First Flight Timer	For your first flight, set to 4:30		

* The default Aura program has Crow disabled, see the full manual for instructions on using **Quick Set** to enable Crow.

Connect your serial receiver to the Aura and bind it to your transmitter. Once this is complete proceed with final configuration.

For more details on compatible receivers, on connecting and binding different receivers, flight modes and radio configuration download the complete Twin Otter 80E manual (link on the cover page) or visit the Aura Wiki at: <https://wiki.flexinnovations.com/wiki/Aura>

Aura Configuration

DEFAULT AURA CONNECTIONS

- S1 – Left Throttle
- S2 - Right Throttle
- S3 – Left Aileron
- S4 – Right Aileron
- S5 – Elevator
- S6 – Rudder
- S7 – Left Flap
- S8 – Right Flap

Port B – Serial Receiver Input

Mini Port A&B – Remote Receiver Inputs

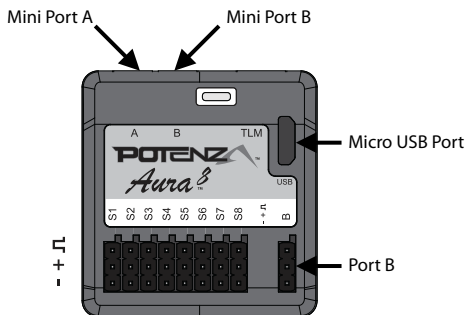

Aura 8 Auto-Detect

Once your receiver is bound, powered, and connected to the Aura, the Aura will begin the Auto-Detect process to learn what type of receiver you are using and set itself up for that specific system. Auto-Detect is indicated by a series of sweeping LEDs of various colors. After Auto-Detect is completed, verify that Aura is on and receiving data from your receiver by looking at the LEDs on the Aura.

Ready-To-Fly:

Solid Orange LED: Aura On and Calibrated



Solid Green LED: Aura receiving Valid receiver data

Possible Errors:

Flashing Orange LED: Aura Moved During Power Up



No Green LED: Aura NOT receiving receiver data

Connecting Battery and Arming ESCs

1. Turn on the transmitter. Lower the throttle stick AND throttle trim to their lowest settings.
2. Ensure the aileron, elevator and rudder gimbals are centered.
3. With the airplane on a solid surface, connect the battery to the ESCs and wait. The ESCs will make the motors emit a series of audible tones during their initialization process.
4. The ESCs will make the motors emit a short, final tone sequence indicating that the ESCs are now armed and that the motors will spin in response to throttle stick movement.

ESC Throttle Calibration

In order to map the full range of the ESCs output to your throttle stick motion you will have to perform an ESC throttle calibration. Both ESCs will calibrate simultaneously so you only need to calibrate once. **NOTE: Execute ESC throttle calibration with the propellers and spinners removed.**

1. Power on your transmitter, DISABLE any throttle hold or throttle kill switches, **completely lower the throttle trim** and set the stick to full throttle.
2. Connect the flight pack to your Twin Otter 80E.
3. Listen for the tones coming from the ESCs through the motors, after about 2 seconds you should hear two tones.
4. Pull your throttle stick back to idle.
5. Listen for the ESC arming tones from the motors.
6. Unplug the flight battery to complete calibration.

Note: After throttle calibration is complete it is necessary to reset the failsafe (see your radio documentation, this may require a re-bind).

Final Radio Setup

In FM1, take this moment to finalize the position of the servo arms and pushrod lengths on your elevator, rudder and nose gear steering and ensure that the motors are spinning in the correct direction, **left motor is CCW and right motor is CW when viewed from the tail of the airplane** (swap any 2 wires to reverse motor rotation).

Make any final control surface adjustments either mechanically or in the Aura, do not use trim or sub-trim.

Control Direction Test

Refer to the chart below to determine the proper control surface directions, test these in Flight Mode 3. To test differential thrust, **PROPELLERS MUST BE REMOVED** and channel 7 must be active (typically throttle hold off).

If any controls are reversed, including the nose gear steering, DO NOT REVERSE CONTROLS IN YOUR TRANSMITTER OR IN THE AURA CONFIG TOOL. Email us at support@flexinnovations.com for corrective action. Note that BOTH the Transmitter Control Direction Test AND the Flight Controller Sensor Direction Test MUST BE PASSED! IF EITHER ONE DOES NOT PASS, DO NOT FLY!

NOTE: There is pre-configured rudder to aileron and rudder to elevator mixing programmed into the Aura. Simultaneous movement of these control surfaces with rudder input is intentional and completely **NORMAL**.

Additionally: Aura has a built-in flap system that moves the flaps at a slower speed. There is also flap to elevator mixing configured in the Aura Flap System. This speed and mixing is intentional and completely **NORMAL**.

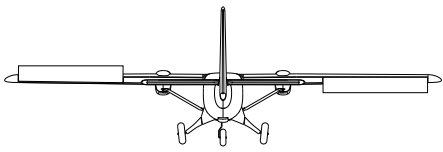
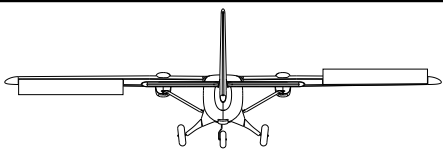
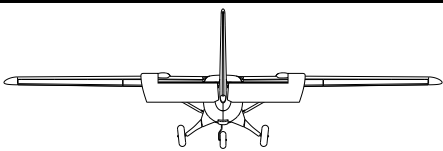
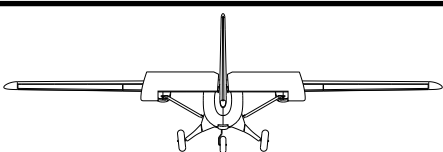
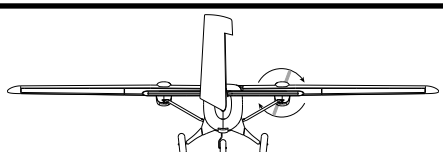
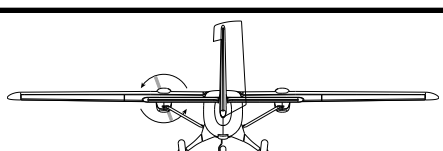
	Transmitter Command	Proper Control Surface Deflection
AILERON	Stick Left	
	Stick Right	
ELEVATOR	Stick Forward	
	Stick Aft	
RUDDER	Stick Left	
	Stick Right	

Aura Sensor Direction Test

Perform a test of the gyro system to verify the corrections made for a given movement are correct. **If any of the tests do not result in the correct reaction from the airplane's gyro system, including the nose gear steering, DO NOT FLY THE AIRPLANE, and contact us via email at support@flexinnovations.com**

The flight control system activates with RF broadcast. Perform these tests in Flight Mode 3 (higher gain) for better visibility and then in the remaining Flight Modes. Control surface deflections are exaggerated in the pictures below for clarity. Please note that the control surfaces will move **ONLY** while the aircraft is being **ROTATED**. To test differential thrust, **PROPELLERS MUST BE REMOVED** and channel 7 must be active (typically throttle hold off).

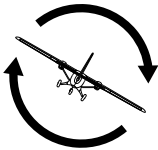
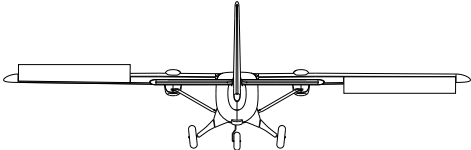
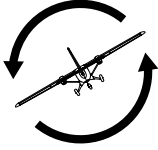
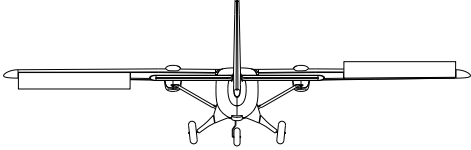
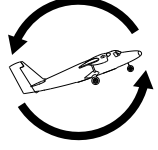
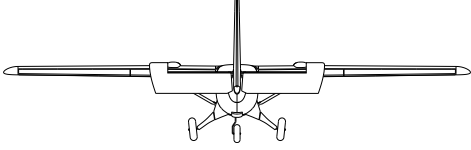
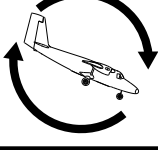
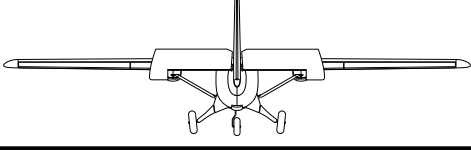
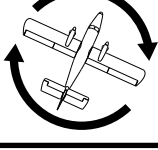
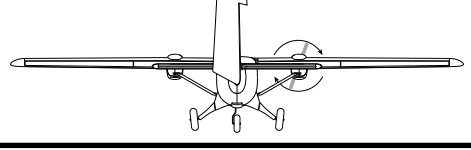
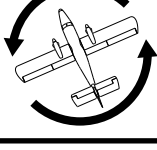
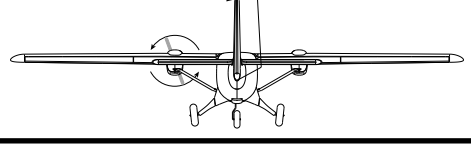
	Aircraft Movement	Proper Control Surface Deflection
AILERON		
		
ELEVATOR		
		
RUDDER		
		

Completion and Flight Readiness

Once your radio and Aura 8 configuration is complete there are only a few steps left to get your Twin Otter 80E in the air:

1. Add thread locker to all servo arm screws on all servos (including nose gear steering and wing servos).
2. Install the nose cone using three M2X7mm self tapping screws (for the night version, connect LEDs).
3. Install the cowlings to the motor nacelles using two M2X13mm self tapping screws. Glue the exhaust to each side of the nacelles using CA or Epoxy.
4. Install the propellers to the motors using the provided washer and nut, note that they are labeled L and R.
5. Install the spinners to the prop adapters using the provided M3X10mm screw (don't use thread locker).
6. Move the battery back and forth as necessary to achieve the desired CG (shown to the right).

Center of Gravity Verification

The Twin Otter 80E does not fly like your typical acrobatic or 3D model, for that reason it is important that you do not stray from the recommended CG. Flex has done extensive flight testing to arrive with this range. In particular, DO NOT fly the airplane more tail heavy than recommended, it will not perform as expected.

The CG is located between 3-5/16 and 3-3/4 inches (85 and 95mm) from the leading edge of the wing.

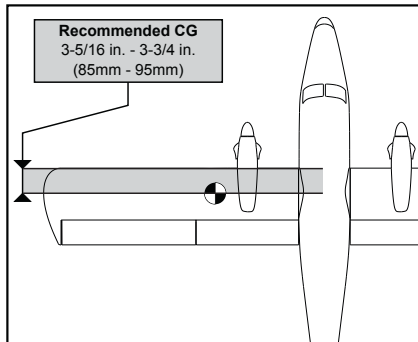

DIFFERENTIAL THRUST WARNING!



The Twin Otter 80E implements differential thrust when in Flight Mode 3, this means that one of the motors can spool up whenever rudder input is provided or the airplane is rotated. For this reason please follow these recommendations:

- Never activate Flight Mode 3 until you are ready to take off, this includes taxiing to and from the runway.
- If the battery is plugged in, always handle and carry the airplane with all body parts clear of the propellers.
- **We recommend that you assign the differential thrust disable switch to your throttle hold and only engage throttle when you have cleared the airplane and are ready to taxi and take off.**

First Flight and Quick Trim

We recommend that you fly the maiden flight using Flight Mode 2. Trim the airplane until you achieve straight and level flight. Once you land execute the below Quick Trim procedure ensuring that you keep Flight Mode 2 selected.

1. Power off the Twin Otter 80E. Insert a bind plug into Aura Port S3 (you will need to remove the servo lead that is currently in S3). Check that the transmitter is powered on and re-power the Aura to enter Quick Trim.
2. Wait 5 seconds for the Aura to completely initialize. Confirm Quick Trim mode is active by checking the Blue LED is slowly flashing.
3. Remove the bind plug to save your trim settings, the Blue LED will now flash quickly indicating the new trim values have been stored successfully. Power off the Twin Otter 80E and re-install the servo into port S3.
4. Center all control surface trims on the transmitter.
5. Re-power the Twin Otter 80E, the control surfaces should be unchanged and new trims have been applied.



© 2023 Flex Innovations, LLC. All rights reserved.
Potenza™ is a trademarks of Flex Innovations LLC
DSM®, DSM2™, and DSMX™ are trademarks of Horizon Hobby, Inc.
Futaba is a registered trademark of Futaba Denshi Kogyo Kabushiki Kaisha Corporation of Japan.
Jeti, UDI, and Jeti Model are trademarks or registered trademarks of Jelen, Ing. Stanislav of Czech Republic
HoTT is a registered trademark of SJ, Inc.