

Instruction Manual

ARF and ARFSV

RV-8 7000 FLS



Giugiaro Tompazini

FeatherLite[™]
SERIES

FLEX[™]
INNOVATIONS



BEFORE CONTINUING WITH THIS INSTRUCTION MANUAL OR THE ASSEMBLY OF YOUR AIRCRAFT, PLEASE VISIT OUR WIKI SUPPORT SITE FOR THE LATEST PRODUCT UPDATES, FEATURE CHANGES AND MANUAL ADDENDUMS FOR THIS PRODUCT.

wiki.flexinnovations.com/wiki/RV-8_70cc

TABLE OF CONTENTS

Introduction	1
Specifications:	1
Required Equipment:	2
Optional Equipment:	4
Hangar 9®/Ultracote®/Oracover® Colors:.....	4
Using this Manual	5
ARF	7
Aileron and Flap Control Horn Installation	7
Control Horn Installation	7
Hinge Installation:.....	9
Main Wing Servos and Linkages Installation	10
Ailerons.....	10
Flaps.....	12
Elevator Installation	13
Control Horn Installation	14
Hinge Installation:.....	14
Elevator Servo and Linkage Installation	15
ARF and ARFSV	18
Rudder, Tailwheel Installation	18
Tail Wheel Installation	18
Rudder and Rudder Control Horn Installation	20
Rudder Hinge Installation	21
Rudder Control Horn Installation.....	22
Rudder Servo and Linkage Installation	24
Push/Pull System, Servo Installed in the Vertical Fin	24
Installing the Vertical Fin	27
Pull/Pull System.....	29
Push/Pull System, Servo Installed in Fuselage	32
Mounting the Stab	34
Landing Gear Installation	35
Engine and Throttle Servo Installation	39
DA-70 Engine Installation	39
DA-70 Throttle Servo and Throttle Linkage Installation	41
DA-60 Engine Installation	43
Throttle Installation.....	45
Ignition Installation	48
Fuel Tank Installation	50
Exhaust and Cowling Installation	53
Muffler Installation (A)	53

Canister Installation (B).....	56
Baffle and Final Cowling Installation	59
Electric Power Setup	63
Motor Installation	63
ESC Installation	65
Battery Tray Installation	66
Motor/ESC Cooling	68
Final Assembly	69
Radio Installation.....	69
Wing Installation.....	72
Pilot Installation (Optional)	75
Canopy Installation	76
Decal Installation	77
Final Setup and Flying Notes.....	84
Center of Gravity.....	84
Aura 8 Professional.....	85
Range Testing.....	86
Before First Flight	86
AMA Safety Code	87
Replacement Parts.....	88
Optional Accessories.....	89
Limited Warranty	90

INTRODUCTION



The RV-8 70cc FLS (Feather Light Series) is a 35% scale model of the famous experimental Van's Aircraft RV-8. Designer and World Champion Quique Somenzini has taken a completely new approach with the design of the RV-8 70cc FLS. A massive airframe, with over 2000 square inches (130.3 sq. dm.) of wing area, that comes in at 23 pounds (10.4 kg) flying weight, offers such an incredibly lightly loaded airframe, it feels like you are flying something lighter than air. Couple the extremely light wing loading with key design and geometric details from the master himself, and you get an aircraft that has a huge flight envelope.

Along with the incredible airframe design of the RV-8 70cc FLS, it is also designed to accept multiple power systems, including 60cc electric setups that allow you to fly anywhere from 5 to 8 minutes on a typical 12S Li-Po setup! We also cannot forget about its float-ready airframe either! The optional RV-8 70cc FLS Float Set includes everything needed to get it on the water and is also available to match your RV-8 70cc FLS' color scheme.

This is an airplane that you need to truly experience for yourself, and once you have, you'll quickly add one to your hangar! From its insane stability at walking speeds with the flaps down, to classic 3D and precision aerobatic maneuvers, the RV-8 70cc FLS has the flight performance and versatility that is for every pilot, of virtually every skill level.

Specifications:

Wingspan:	100 in. (2540 mm)
Length:	90 in. (2288 mm)
Gas Weight: (DA-70 w/MTW TDH110 Canister)	23 lb. 3 oz. (10.5 Kg)
Electric Weight: (Potenza 65cc w/12S 6200mAh)	24 lb. 15oz. (11.3 Kg)
Engine/Motor Size:	60-70cc

Required Equipment:

Radio Equipment & Servos:

Transmitter:	8+ channels
Receiver:	8+ channels, high-voltage capable
Receiver Battery:	(2) 2S 4000mAh 15C+ LiPos (FPZBR40002S15 recommended)
Receiver Battery Strap:	(1) Flex Hook and Loop Strap, 300 mm long (FPMA1016)
Aileron, Flaps, Elevators Servos:	(6) Minimum 200 oz/in (14 kg/cm) Potenza DS22209HV high voltage servos recommended.
Rudder Servo:	Minimum 400 oz/in (28 kg/cm) Potenza DS494010HV brushless high voltage servo recommended.

Servo Arms:

Aileron, Flaps, Elevators:	(6) 2-inch Single Arm Potenza 2-inch Clamping Servo Arm – FPZA1036 recommended.
Rudder: (Tail-mounted Push-Pull)	2-inch Single Arm Potenza 2-inch Clamping Servo Arm – FPZA1036 recommended.
Rudder: (Front-Mounted Pull-Pull)	4-inch Double Arm Potenza 4-inch Clamping Servo Arm – FPZA1037 recommended.

Servo Extensions:

Ailerons:	(2) 18-inch (460 mm)
Flaps:	(2) 9-inch (230 mm)
Flaps & Ailerons: (To the receiver or Aura)	(2) 9-inch (230 mm)
Elevators:	(2) 48-inch (1220 mm)
Rudder: (Tail-mounted Push-Pull):	48-inch (1220 mm)
Servo Extension Safety Clips:	Flex Servo Connector Safety Clips (FPZA1040)

Spinner:

Spinner:	5 inch (140 mm) Falcon 5-inch Carbon Fiber Spinner – FPMFAL5CGS recommended
----------	--

Gas Engine Setup

Engine:	60cc to 70cc Gasoline two-stroke engine Desert Aircraft DA-70 – FPMDA70 recommended
Exhaust:	Follow your engine manufacturer’s recommendation, as well as local noise restrictions in your area. DA stock muffler set by Slimline – FPMDA70MUFFLER recommended for DA-70.
Other Exhaust Options:	MTW TDH110 Rear Discharge Canisters for the DA-70 KS 60 mm drop 2 to 1 header for the DA-70 KS86 Rear Discharge Canister for DA-60 MTW Flexible header 60 mm drop for DA-60
Propeller:	Follow your engine manufacturer’s recommendation. Falcon Carbon Fiber 25x8W recommended for the DA-70
Engine Standoffs:	(4) 20 mm Aluminum Standoffs for DA-70 or (4) 30mm Aluminum Standoffs for DA-60 FPM1624 recommended for DA-70
Throttle Servo:	High Quality, Metal Gear Digital Servo Potenza DS22209HV high voltage servo recommended.
Throttle Servo Extension:	18-inch (460 mm)
Ignition Regulator:	Follow your engine manufacturer’s recommendation.
Ignition Strap:	Flex Hook and Loop Strap, 200mm long (FPMA1012)
Ignition Battery	2S 2000mAh 15C+ Li-Po FPZBR20002S15 recommended
Ignition Battery Strap:	Flex Hook and Loop Strap, 200 mm long (FPMA1012)
Fuel Tank Strap?	(1) FPMA1014 (2) Battery Hook and Loop Strap Small 260mm Long (1) FPMA1013 (2) Battery Hook and Loop Strap Small 220mm Long
Fuel Dot:	McFueled Fuel Dot (FPMAMCFUELER)

Electric Setup

Motor:	60-70cc Brushless Motor Equivalent Potenza High Performance 65cc 185KV Brushless Motor FPZM65CC recommended.
ESC:	160A HV ESC Castle Creations Phoenix Edge 160HV, 50V ESC recommended.
Flight Batteries:	2 x 6S 6200mAh Li-Pos Potenza 6S 6200mAh 40C Li-Pos recommended.
Flight Battery Straps	(2) Flex Hook and Loop Strap, 300mm long (FPMA1016)

Propeller:	Follow your motor manufacturer's recommendation. Mejzlik 25x12S recommended for the Potenza 65cc Brushless Motor.
Motor Standoffs:	(4) 2-½ inch (63mm) Motor Standoffs
ESC Servo Extension:	18-inch (460 mm)

Optional Equipment:

FPZAURA08PRO	Aura 8 Professional
FPM2019	24oz Lightweight Fuel/Smoke Tank (for smoke)
FPM1623	32oz Fuel Tank (larger tank for longer flight times)
FPMHOLYG2	Holy Smokes G2 Smoke System
FPM2014	Flex Innovations Premium Wing and Tail Bag Set
ISDTD2	ISDT D2 Dual Port AC 200W Charger
FPM2022	Premium Vinyl Graphics Set, RV-8 70cc FLS, Red Scheme (by Callie Graphics)
FPM2023	Premium Vinyl Graphics Set, RV-8 70cc FLS, Camouflage Scheme (by Callie Graphics)
FPMAMCFUELER	McFueller Fuel Dot

Hangar 9®/Ultracote®/Oracover® Colors:

Camouflage Scheme:

Ultracote®	Oracover®
Olive Drab (HANU904)	Olive Drab 21-018
Light Gray (HANU882)	Grey 210-011
Orange (HANU877)	Orange 21-060
White (HANU870)	White 21-010
Black (HANU874)	Black 21-071

Red, White and Blue Scheme:

Ultracote®	Oracover®
True Red (HANU866)	Ferrari Red 21-023
Midnight Blue (HANU885)	Dark Blue 21-052
Silver (HANU881)	Silver 21-091
White (HANU870)	White 21-010

USING THIS MANUAL

This manual is for both the ARF and ARFSV versions.

The manual is divided into sections to make the assembly of the airplane easier to follow.

If you have an ARFSV, many of the steps will be completed for you, however, it is important that you read through this entire instruction manual to familiarize yourself with this aircraft.

Note: the squares "□" next to each step that can be checked off to help you keep track of the steps that have been completed.

ATTENTION

Read the ENTIRE instruction manual to become familiar with the features and assembly of the product before assembly. Failure to assemble or operate the product correctly can result in damage to the product, personal property and cause serious or fatal injury.

All instructions, warranties and other collateral documents are subject to change at the sole discretion of Flex Innovations, LLC. For up-to-date product literature, please visit our website at www.flexinnovations.com and navigate to the product page for this product.

WARNING

This is NOT a toy. This product is not intended for use by children under 14 years of age without direct adult supervision.

IMPORTANT INFORMATION REGARDING WARRANTY

Please read our Warranty and Liability section before building this product. If you as the purchaser or user are not prepared to accept the liability associated with the use of this product, you are advised to return this product immediately in new and unused condition, in the original packaging material, to the place of purchase.

SAFETY WARNINGS AND PRECAUTIONS

Protect yourself and others by following these basic safety guidelines.

1. This manual contains instructions for safety, operation, and maintenance. It is essential to read and follow all the instructions in the manual, prior to assembly, setup, or use, in order to operate correctly and avoid damage or serious injury.
2. In some cases, the written instructions may differ slightly from the photos. In those instances, the written instructions should be considered correct.
3. This model is not a toy, rather it is a sophisticated hobby product and must be operated with caution and common sense. This product requires some basic mechanical ability. Failure to operate this product in a safe and responsible manner could result in injury, or damage to the product, or other property.
4. This model must be assembled according to these instructions. Do not alter or modify the model outside of these instructions provided by Flex Innovations, LLC, as doing so may render it unsafe and/or unflyable. You must take time to build straight, true, and strong. It is your responsibility to ensure the air worthiness of this product.
5. Use only compatible, appropriate components for the final assembly of this model. Ensure that the radio system is in functional condition, that the engine is appropriately sized for the model and that all other components are appropriate for use in this model as specified in this

instruction manual. All components must be installed correctly so that they operate correctly both on the ground and in the air.

6. Inspect and check operation of the model and all its components before every flight.
7. If you are not an experienced pilot, or have not flown a high-performance model before, it is recommended that you seek assistance from an experienced pilot in your R/C club for your first flights. If you're not a member of a club, the Academy of Model Aeronautics (AMA) has information about clubs in your area whose membership includes experienced pilots.
8. Keep the propeller area clear from such items as loose clothing, jewelry, long hair, or tools, as they can become entangled. Keep your hands and body parts away from the propeller as injury can occur.

SPECIAL LANGUAGE DEFINITIONS

The following terms are used throughout the product literature to indicate various levels of potential harm when operating the product.

- NOTICE:** Procedures, which if not properly followed, create a possibility of physical property damage AND a liable or no possibility of injury.
- CAUTION:** Procedures, which if not properly followed, create a probability of physical property damage AND a possibility of serious injury.
- WARNING:** Procedures, which if not properly followed, create the probability of property damage, collateral damage and serious injury OR create a high probability of serious injury.

IMPORTANT BEFORE ASSEMBLY

Carefully unpack your aircraft and inspect the parts. Review the manual and gather the required tools and supplies.

- Remove all parts from their plastic bags, inventory all items and closely examine all the major airframe components for damage. If any items are missing or you find damaged components, do not proceed. Please contact customer support.
- Use a covering iron with a covering sock on high heat to tighten the covering as necessary, paying special attention to the leading edges of the flying surfaces, hinge lines and stabilizer and wing saddle areas. Apply slight pressure over sheeted areas to thoroughly bond the covering to the wood. Use caution around seams to prevent inadvertently pulling them loose.
 - **Pro-Tip:** You can use a "Seal-It Pen" to permanently seal any sharp edges or corners of covering that may come loose in flight.
- Use thin CA to go over any important glue joints, such as the motor box, firewall, servo mounting rails and any other pre-assembled joints that may see high stress during flight.
- Gather all required components such as motor and radio equipment that will be used to equip the airplane. Create a new radio program in your transmitter and bind this model program to the receiver that will be used in the airplane
- **IMPORTANT NOTE:**
The canopy is attached to the fuselage differently than you may have experienced with other aircraft. To remove it, remove the two screws. Slide the canopy to the rear (DO NOT LIFT UP). Once the canopy has been moved aft approximately 1/2-inch (12mm), lift at the rear and continue moving the canopy to the rear as it is lifted away from the fuselage.

ARF

If your airplane is the ARF version start building from this page through the end of this manual.

AILERON AND FLAP CONTROL HORN INSTALLATION

Required for this section

Components

- Main Wing Panels (2)
- Aileron Control Horns (4)
- Aileron Control Horn Base Plates (2)
- Flap Control Horns (4)
- Flap Control Horn Base Plates (2)
- Aileron and Flap hinges (16)

Tools

- Hobby Knife with a #11 blade

Adhesives/Building Materials

- Isopropyl Alcohol
- 30-minute Epoxy
- Petroleum Jelly
- Paper Towels
- Toothpicks
- Mixing Cups
- Mixing Sticks (something to mix epoxy with)

The flap and aileron control horns have been marked and bagged individually. It is especially important that you use the correct control horns corresponding to each control surface.

The Flap control horns do not align with the flap hinge line, rather they are offset towards the rear of the wing, while the aileron control horns align with the aileron hinge line.

Control Horn Installation



- 1. Prepare the control horns by scuffing the portion of the control horn that is inserted into the control surface with medium grit sandpaper. Use isopropyl alcohol and a paper towel to clean the control horn and remove any debris left over after scuffing.

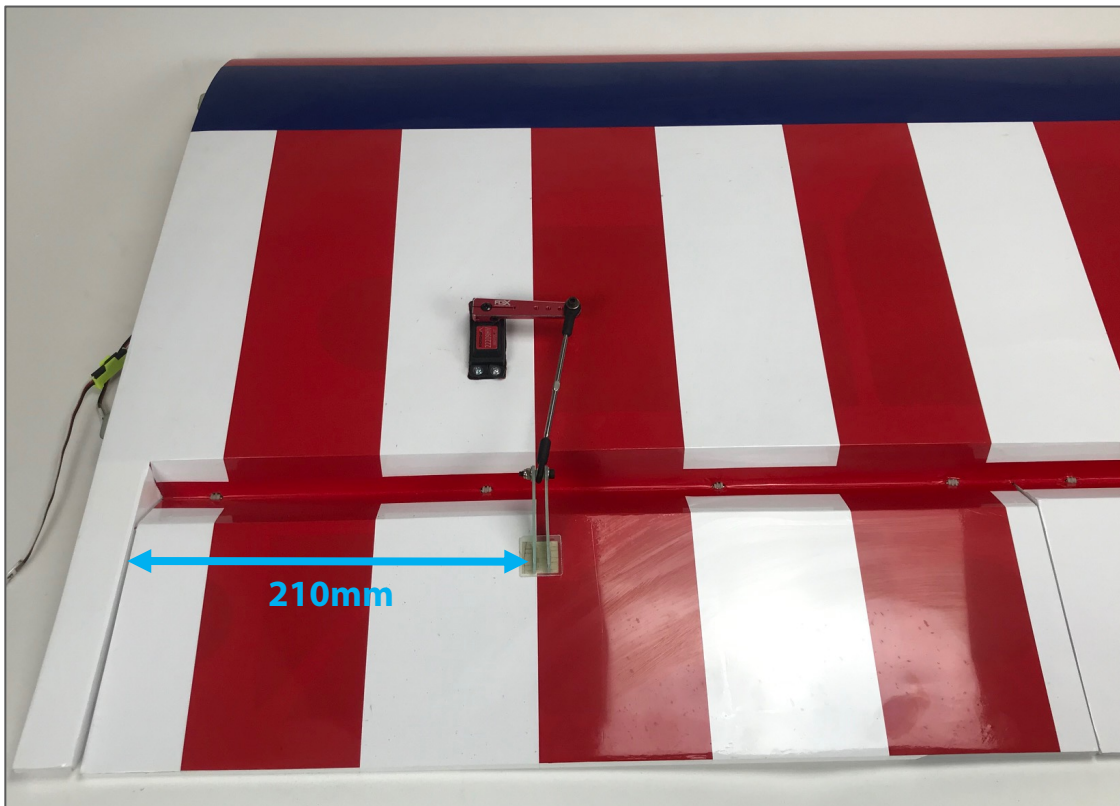

2. Locate the aileron and flap control horn slots. You can find them close to the front edge of the control surface.



- 3. Remove the covering using a hobby knife as shown in the picture above.
- 4. Mix an adequate amount of 30-minute epoxy. Apply epoxy to the slot in the control surface as well as the control horns. Install the control horn and check for proper alignment. Use isopropyl alcohol and a paper towel to clean up any excess epoxy before it cures. Let it sit until the epoxy cures.

Quique's Tip:

To ensure proper alignment of each control horn, you can secure the ball link to the horns and then glue the horn in place with the ball link attached. This will ensure even alignment of both control horns.

Hinge Installation:

- 1. Use a hobby knife to open holes in the covering for each hinge in the wings, ailerons and flaps. Test fit the hinges. Check for minimal hinge gap and overall alignment.
- 2. Use medium grit sandpaper to scuff the portion of each hinge that is inserted into the wing, aileron or flap. Use isopropyl alcohol and a paper towel to clean the hinge and remove any debris that may be left after scuffing.
- 3. Use a toothpick or cotton swab to apply a small amount of petroleum jelly to the pivot point of each hinge. Do not apply petroleum jelly to the entire hinge. The petroleum jelly is used to prevent glue from adhering to the pivot of the hinge, keeping the hinge moving free.
- 4. Mix an adequate amount of 30-minute epoxy and apply epoxy to the hinge slots in the aileron. Insert a hinge into each slot in the aileron. Check for proper alignment. Use isopropyl alcohol and a paper towel to clean up any excess epoxy before it cures.
- 5. Repeat this process with the flaps.
- 6. Repeat this process for gluing the hinges to the wing. Use masking tape or equivalent to hold the aileron and flaps in a neutral position. Make sure the hinge gap is as tight as possible, while still allowing for proper control surface deflection. Wait at least 1 hour before removing the tape and testing the control surfaces.

MAIN WING SERVOS AND LINKAGES INSTALLATION

Required for this section

Components

- Main Wing Panels (2)
- Aileron Linkage (2)
- Aileron Servos (2)
- Aileron Servo Arms (2)
- 18-inch (460 mm) Aileron servo extensions (2)
- Flap Linkage (2)
- Flap Servos (2)
- Flap Servo Arms (2)
- 9-inch (230 mm) Flap servo extensions (2)
- Ball Links (8)
- M3 x 15 Socket Head Cap Screw (8)
- M3 Washer (16)
- M3 Lock Nut (8)

Tools

- #1 Phillips Screwdriver
- 2.5mm Hex Driver
- 5.5mm Nut Driver

Adhesives/Building Materials

- Thin CA
- Blue Thread Lock
- Servo Connector Safety Clip

Ailerons

1. Use a #1 Phillips screwdriver to thread a servo mounting screw into each of the pre-cut holes in the servo mounting rails in the wing. Remove the screw and apply a small amount of thin CA to each of the holes to harden the threads cut by the screw. Do not use CA accelerator. Let the CA fully cure before moving forward.
2. Secure an 18-inch (460 mm) servo extension to each of the Aileron servos. Use Flex Servo Connector Safety Clips (FPZA1040), heat shrink tubing or thread to secure the connection.
3. Insert the aileron servo into the servo bay with the output shaft towards the leading edge of the wing. Be sure to route the servo lead out of the wing before mounting the servo. Mount the servo to the wing using the servo mounting screws provided with your servos. Be sure to install the servos with the long servo extensions in the outside servo openings of the wing panels (aileron location) and not in the openings close to the root of the wing panel where the flap servos will be installed.
4. Use your radio system to center your aileron servos. Install your aileron servo arm onto the servo as close to parallel with the hinge line as possible. Apply blue thread lock to the servo arm screw and fully tighten the screw. If your servo arms have output shaft clamping screws, apply blue thread lock, and secure them in place at this time.
5. Using a pushrod with a length of 2-3/4 inches (70mm), assemble the aileron linkages so that the total length from center of ball to center of ball is approximately 95mm. Final length will be adjusted when centering the control surface. Note that the opposite ends of each aileron linkage have opposite direction threads.

- 6. Attach the linkage to the servo arm. The correct hole location is 2-inches (50.8mm) from center. If using the recommended 2-inch servo arm, this is the outermost hole.
- 7. With the radio powered-on and the servo centered with the arm parallel to the hinge line, adjust the linkage length so that the control surface is centered. When satisfied with the length of the linkage, secure the linkage to the control horn with the hardware in the following order:
 - M3x15 Socket Head Cap Screw
 - M3 Washer
 - Control Horn (Side 1)
 - Ball Link
 - Control Horn (Side 2)
 - M3 Washer
 - M3 Lock Nut



After the steps above are completed and the servo and linkages are installed, the assembly should appear as shown in the picture above. Both ailerons should appear the same but mirrored accordingly.

Note: The angle of the linkage is correct. As the servo arm rotates and the control surface deflects, the linkage will straighten.

Flaps

1. Use a #1 Phillips screwdriver to thread a servo mounting screw into each of the pre-cut holes in the servo mounting rails in the wing. Remove the screw and apply a small amount of thin CA to each of the holes to harden the threads cut by the screw. Do not use CA accelerator. Let the CA fully cure before moving forward.
2. Secure a 9-inch (230mm) servo extension for to two of the Flap servos. Use Flex Servo Connector Safety Clips (FPZA1040), heat shrink tubing or thread to secure the connection.
3. Insert the Flap servo into the servo bay with the output shaft towards the leading edge of the wing. Be sure to route the servo lead out of the wing before mounting the servo. Mount the servo to the wing using the servo mounting screws provided with your servos.
4. Use your radio system to center your flap servos. Install your flap servo arm onto the servo as close to parallel with the hinge line as possible. Apply blue thread lock to the servo arm screw and fully tighten the screw. If your servo arms have output shaft clamping screws, apply blue thread lock, and secure them in place at this time.
5. Using a pushrod with a length of 3.5 inches (90mm), assemble the flap linkages so that the total length from center of ball to center of ball is approximately 112mm. Note that the opposite ends of each flap linkage have opposite direction threads.
6. Attach the linkage to the servo arm. The correct hole location is 2-inches (50.8mm) from the center of the servo arm. If using the recommended 2-inch servo arm, this is the outermost hole.

Quique's Tip:

In order to get the best performance out of the RV-8 70cc FLS, I recommend the use of a Live Wing, which mixes the flap servos with the ailerons to get a full-span aileron. The flap surface and servo centering is different than in traditional flap setups, so be sure to follow the next steps closely.

7. With the radio powered on and the servo centered with the arm parallel to the hinge line, adjust the linkage length so that the flap is even with the aileron at its neutral position. This will allow for the flap to travel in both up and down directions. When satisfied with the length of the linkage, secure the linkage to the control horn with the hardware in the following order:
 - M3x15 Socket Head Cap Screw
 - M3 Washer
 - Control Horn (Side 1)
 - Ball Link
 - Control Horn (Side 2)
 - M3 Washer
 - M3 Lock Nut



After these steps are completed and the linkages are installed, the assembly should appear as shown in the above picture. Both flaps should appear the same, though mirrored on their respective sides.

Note: The angle of the linkage is correct. As the servo arm rotates and the control surface deflects, the linkage will straighten.

ELEVATOR INSTALLATION

Required for this section

Components

- Elevator Control Horn (4)
- Control Horn Base (2)
- Left and Right Horizontal Stabs

Tools

- Hobby Knife with a #11 Blade

Adhesives/Building Materials

- Isopropyl Alcohol
- 30-Minute Epoxy
- Paper Towels
- Mixing Cups
- Mixing Sticks
- Toothpicks

Control Horn Installation

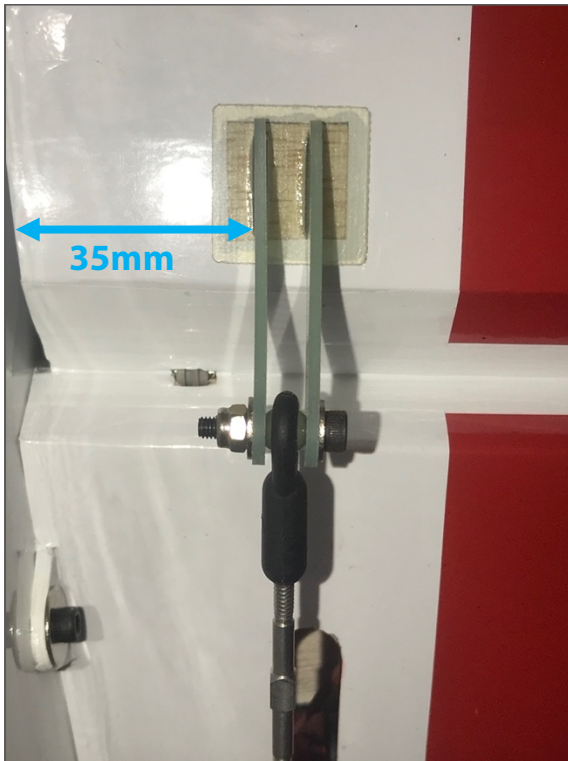

1. Use a hobby knife with a #11 blade to remove the covering from the bottom side of the elevators. The control horn slots are approximately 1-1/8-inches (35mm) from the elevator edge as shown in the picture.
2. The elevator horns are bagged and marked. Prepare the control horns by scuffing the portion of the control horn that extends into the control surface with medium grit sandpaper. Use isopropyl alcohol and a paper towel to clean the control horn and remove any excess debris left after scuffing.
3. Mix an adequate amount of 30-minute epoxy. Apply epoxy to the control horn slots in the elevator as well as the control horn. Push the control horns into the slot, being sure to wipe away any excess epoxy with isopropyl alcohol and a paper towel.

Quique's Tip:

To better help align the control horns with one another, use the provided hardware to secure the control horns to the ball link. This will keep them aligned while they are glued in place.

Hinge Installation:

1. Use a hobby knife to open holes in the covering for each hinge in the horizontal stabs and elevators. Test fit the hinges. Check for minimal hinge gap and overall alignment.
2. Use medium grit sandpaper to scuff the portion of each hinge that is inserted into the horizontal stabs or elevators. Use isopropyl alcohol and a paper towel to clean the hinge and remove any debris that may be left after scuffing.

- 3. Use a toothpick or cotton swab to apply a small amount of petroleum jelly to the pivot point of each hinge. Do not apply petroleum jelly to the entire hinge. The petroleum jelly is used to prevent glue from adhering to the pivot of the hinge, keeping the hinge moving free.
- 4. Mix an adequate amount of 30-minute epoxy and apply epoxy to the hinge slots in the elevator. Insert a hinge into each slot in the elevator. Check for proper alignment. Use isopropyl alcohol and a paper towel to clean up any excess epoxy before it cures.
- 5. Repeat this process for gluing the hinges to the horizontal stabs. Use masking tape or equivalent to hold the elevators in a neutral position. Make sure the hinge gap is as tight as possible, while still allowing for proper control surface deflection. Wait at least 1 hour before removing the tape and testing the control surfaces.

ELEVATOR SERVO AND LINKAGE INSTALLATION

Required for this section

Components

- Horizontal Stabilizer Assemblies (2)
- Horizontal Stabilizer Carbon Fiber Tube
- Fuselage
- Elevator Servo (2)
- Elevator Servo Arm (2)
- 48-inch (1250mm) Servo Extension (2)
- Left and Right Horizontal Stabs
- M3x15 Socket Head Cap Screw (8)
- M3 Washer (8)
- M3x12 Washer (4)
- M3 Lock Nut (4)

Tools

- 2.5mm Hex Driver
- 5.5mm Nut Driver
- #1 Phillips Screwdriver

Adhesives/Building Materials

- Servo Connector Safety Clip

- 1. Use a #1 Phillips screwdriver to thread a servo mounting screw into each of the holes in the servo mounting rails in the horizontal stabilizer. Remove the screw and apply a small amount of thin CA to each of the holes to harden the threads cut by the screw. Let the CA fully cure before moving forward.

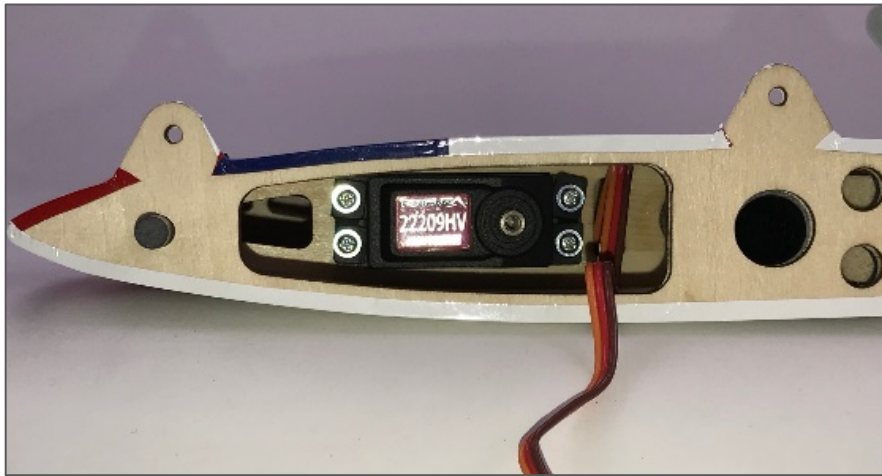

2. Insert the elevator servo into the mounting location with the output shaft towards the horizontal stab tube. Mount the servo to the stab using the mounting screws provided with your servos. Note that the servo wire will exit on the stab tube side of the servo.
3. Power on your radio system to center the servo. Install a 2-inch (51mm) servo arm onto the servo. Apply a small amount of blue thread lock to the servo arm screw and secure it in place. If your servo arm has clamping screws, apply blue thread lock to these screws and secure them in place. Note that you may need to power off the model and rotate the servo arm by hand to have access to each clamping screw.
4. Using a pushrod of 2 1/8-inch (55mm) length, assemble the elevator linkages and ball links so that the total length from center of ball to center of ball is approximately 3-1/8-inches (78mm). Final length will be adjusted when centering the control surface. Note that both ends of the elevator linkages have opposite direction threads.
5. Attach the linkage to the servo arm. The correct hole location is 1 3/4-inches (44mm) from the center of the servo arm. If you are using the recommended servo arm, this is the second hole from the outside. The order of hardware components, starting from the top of the servo is as follows:
 - M3x15 socket head cap screw
 - M3 washer
 - Ball Linkage
 - Servo Arm
 - M3 washer
 - M3 locknut
6. Attach the linkage to the control horn. The order of hardware components, starting from the tip of the stabilizer is as follows:
 - M3x15 socket head cap screw
 - M3 washer
 - Control Horn #1
 - Ball Linkage
 - Control Horn #2
 - M3 washer
 - M3 locknut

- 7. With the radio powered on and the servo arm centered perpendicular to the servo case, adjust the linkage length so that the control surface is centered.

Quique's Tip:

For elevator centering, it is best to install the stabilizers onto the fuselage and stand approximately 10 feet (3m) behind the aircraft while sighting the two elevator halves. Using this method, you can best align the most important part of the control surface, the widest part, rather than referencing something less important, like the elevator counterbalance.



- 8. After installation is complete, your linkage setup should match the image above. Repeat the same procedure for the other horizontal stabilizer.

ARF AND ARFSV

If your airplane is an ARFSV you can start from this page.

However, for instructions on the assembly of the aileron, flap and elevator pushrods, please reference the ARF steps on pages 7 through 17.

RUDDER, TAILWHEEL INSTALLATION

Required for this section

Components

- Tailwheel M3 Washer (X2)
- Rudder
- Tailwheel Wire
- Tailwheel Bracket
- Tail wheel
- Lock Collar (2)

Tools

- Flat File
- 1.5mm Hex Driver

Adhesives/Building Materials

- 30-Minute Epoxy
- Blue Thread Lock
- Epoxy Mixing Cups
- Low-Tack Masking Tape
- Isopropyl Alcohol
- Paper Towels
- Mixing Sticks

Tail Wheel Installation



1. Scuff the fiberglass half hinge to prepare it for installation. Clean both the wire and half hinge with a paper towel and isopropyl alcohol before proceeding.
2. The aluminum tail wheel bracket has 3 holes. 2 are slightly smaller than the other. Assemble the tail wheel wire and bracket by routing the L bend side of the wire through

the largest hole in the aluminum bracket. The large hole is just big enough to fit the wire through it. It may be snug, but do not drill out this hole as it is important to keep this tolerance tight for the longevity of your tail wheel bracket. Slide the fiberglass half hinge over the L bend side of the tail wheel wire.

- 3. Use a file to make two small flat spots on the inside and outside of the tail wheel wire for the lock collar set screws
- 4. Finish the tail wheel bracket assembly by sliding a M3 wheel collar onto the tail wheel axle with the flange facing the wheel location. Apply blue thread lock to a setscrew and secure the wheel collar to the tail wheel wire. Apply a drop of light oil on the axle and slide the tail wheel onto the axle. Install another wheel collar, with the flange facing the tail wheel, and use blue thread lock when securing the set screw in place. Be sure the collars are spaced so that the tailwheel spins freely.



- 5. Mix an adequate amount of 30-minute epoxy. Hold the rudder with the leading edge up and apply the epoxy to the tail wheel wire hole, as well as the slot for the half hinge. Insert the wire and half hinge fully into their holes. Use isopropyl alcohol and a paper towel to clean up any excess epoxy. Let these parts dry for at least 1 hour before continuing with the rudder installation.

Rudder and Rudder Control Horn Installation

Required for this section

Components

- Rudder hinges (3)

Tools

- Hobby Knife with a #11 blade

Adhesives/Building Materials

- Isopropyl Alcohol
- 30-minute Epoxy
- Mixing Cups
- Mixing Sticks
- Paper Towels
- Petroleum Jelly

Quique's Tip:

The RV-8 70cc FLS has 3 different rudder servo locations. Two in the tail, and one in the cockpit area for a pull-pull rudder setup.

The rudder servo position can greatly affect the center of gravity so you should select a servo mounting positions that achieves the correct center of gravity to maintain the same flight performance. For the lighter 60cc single cylinder engines, the front location for pull-pull must be used for a proper CG. If you choose to use a 70cc twin cylinder engine, you can mount the rudder servo in one of the two positions in the tail. If using any other type of engine, it's recommended that you do not install the rudder servo until you have the rest of the airplane complete and can check CG to see where the best place for the servo should be.

The two tail-mounted rudder servo locations are located above and below the horizontal stabilizer. The location below the horizontal stabilizer helps hide the servo and linkage better, but the downside is that it requires you to disconnect the servo linkage if you want to remove the vertical fin for transport or storage. The second location above the horizontal stabilizer makes removal and transport easier, as the servo is mounted in the removable section of the vertical fin, but the servo and linkage are more visible. Choose the location that fits your needs best!

Rudder Hinge Installation



1. Locate the rudder and the vertical fin. Use a hobby knife to open holes in the covering for each hinge in the rudder and the fin. Test fit the hinges. Check for minimal hinge gap and overall rudder alignment.
2. Use medium grit sandpaper to scuff the portion of each hinge that is inserted into the fuselage or rudder. Use isopropyl alcohol and a paper towel to clean any debris that may be left on the hinge after scuffing.
3. Use a toothpick or cotton swab to apply a small amount of petroleum jelly to the pivot point of each hinge. Do not apply petroleum jelly to the entire hinge. The petroleum jelly is used to prevent glue from adhering to the pivot of the hinge, keeping the hinge moving free.
4. Mix an adequate amount of 30-minute epoxy and apply epoxy to the 3 hinge slots in the rudder. Insert a hinge into each hinge slot in the rudder, while being sure to check for proper hinge orientation and alignment. Use isopropyl alcohol and a paper towel to clean up any excess epoxy before it cures.
5. Repeat this process for gluing the hinges to the fin. Use low-tack masking tape to hold rudder tight against the fin in its neutral position. Make sure the hinge gap it is as minimal as possible, while still allowing for full travel of the rudder. Wait for at least 1 hour to remove the tape and move the control surface.

Rudder Control Horn Installation

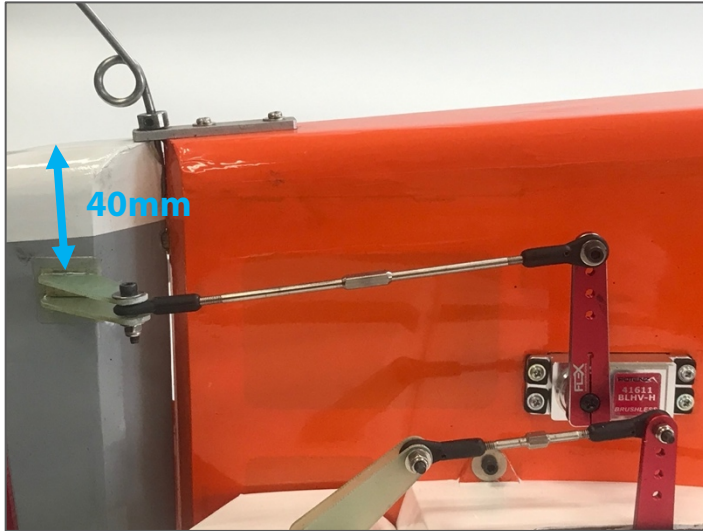

1. There are two control horn locations for the rudder depending on your setup. If using the pull-pull rudder setup, remove the covering from BOTH sides of the upper control horn slots. If using a push-pull rudder setup, remove covering ONLY from ONE SIDE of the control horn slot at your chosen location.
2. At the correct location matching your rudder servo installation use a hobby knife with a #11 blade to remove the covering from the appropriate side(s) of the rudder to expose the mounting slots for the control horn(s).
3. The Rudder control horns are marked. They are marked as follows:
 - “Pull”: To be used with the Pull/Pull cable installation. Total of 4 control horns; two horns for the left side and two horns for the right side in the upper rudder spot, 40mm from the bottom edge as shown in the picture on the left.
 - “Fin”: To be used with the servo mounted in the fin. Total of two control horns. These two control horns are installed on the right side of the rudder in the higher location. 210mm from the bottom edge as shown in the picture on the right.
 - “Rud”: To be used with the servo mounted in the side of the fuselage under the horizontal stabilizer. Total of two control horns. They can be installed on the right or left side as the airplane has both right and left side rudder servo trays. These horns are installed 40mm from the bottom edge of the rudder as shown in the picture on the left.



- 4. Prepare the control horns of your choice by scuffing the portion of the control horn the extends into the control surface with medium grit sandpaper. Use isopropyl alcohol and a paper towel to clean the control horns and remove any excess debris left after scuffing.
- 5. Mix an adequate amount of 30-minute epoxy. Apply epoxy to the control horn slots in the rudder as well as the control horn. Push the control horns into the slot, being sure to wipe away any excess epoxy with isopropyl alcohol and a paper towel.

Quique's Tip:

To ensure proper alignment of each control horn, you can secure the ball link to the horns and then glue the horn in place with the ball link attached. This will ensure even alignment of both control horns.

RUDDER SERVO AND LINKAGE INSTALLATION

Note: As mentioned on page 20, the RV-8 has three different locations for the installation of the rudder servo. These options will be covered one by one. Skip the sections that are not relevant to your installation but do not skip the section covering the installation of the vertical fin.

Push/Pull System, Servo Installed in the Vertical Fin

Required for this section

Components

- Vertical Fin assembly
- Vertical Fin Carbon Fiber Tube
- 48-inch (1220mm) Servo Extension
- Fuselage
- M3x15 Socket Head Cap Screw (4)
- M3 Washer (4)

Tools

- Hobby Knife with a #11 blade
- #1 Phillips Screwdriver
- 2.5mm Hex Driver

Adhesives/Building Materials

- Thin CA
- Blue Thread Lock

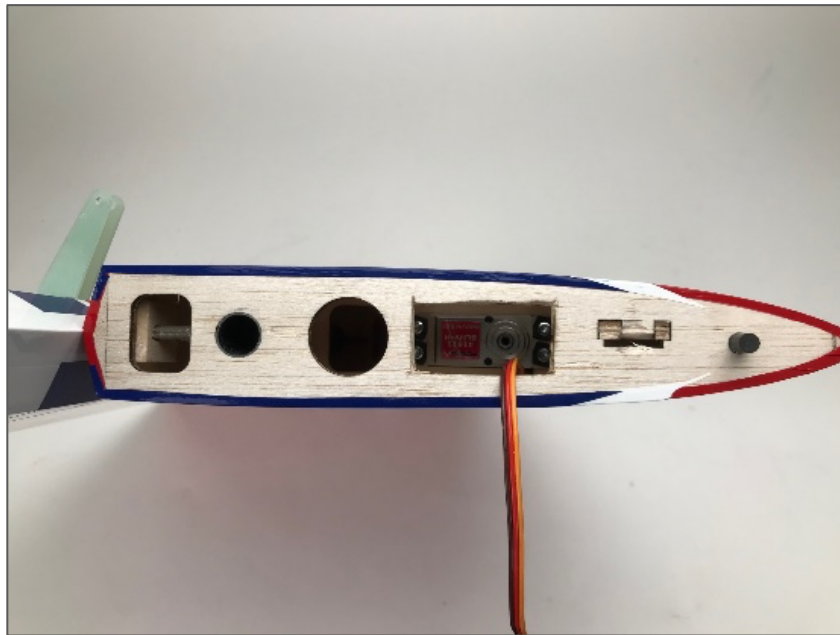

1. Use a #1 Phillips screwdriver to thread a servo mounting screw into each of the pre-cut holes in the servo mounting rails in the vertical fin. Remove the screw and apply a small amount of thin CA to each of the holes to harden the threads cut by the screw. Let the CA fully cure before moving forward.
2. Insert the Rudder servo into the mounting location with the output shaft towards the leading edge of the vertical fin. Mount the servo to the stab using the mounting screws provided with your servos. Note that the servo wire will exit toward the leading edge of the vertical fin.



3. On the right side of the vertical fin, using a #11 blade, open the servo arm slot. This is located 1 3/16 inches (30 mm) from the fin's root.



4. Attach a 48-inch (1220mm) servo extension to the servo. Use Flex Servo Connector Safety Clips (FPZA1040), thread or heat shrink tubing to secure the extension in place (note: if you plan on removing the vertical fin for transport use a Flex Servo Connector Safety Clip,

do not use heat shrink or thread). Route the servo extension through the holes in the formers as shown in the picture above.



5. Power on your radio system to center the servo. Install a 2-inch (50.8mm) servo arm onto the servo. Apply a small amount of blue thread lock to the servo arm screw and secure it in place. If your servo arm has clamping screws, apply blue thread lock to these screws and secure them in place. Note that you may need to power off the model and rotate the servo arm by hand to have access to each screw.
6. Using a pushrod of 4-3/4-inches (120mm) in length, assemble the rudder linkage so that the total length from center of ball to center of ball is approximately 5.7-inches (145mm). Final length will be adjusted once the linkage has been attached to the servo and control horn.
7. Attach the linkage to the servo arm. The correct hole location is 2-inches (50.8mm) from the center of the servo arm. If you are using the recommended servo arm, this is the outermost hole. The order of hardware components, starting from the top of the servo is as follows:
 - M3x15 socket head cap screw
 - M3 washer
 - Ball Linkage
 - Servo Arm
 - M3 washer
 - M3 locknut
8. Attach the linkage to the control horn. The order of hardware components, starting from the tip of the vertical fin is as follows:
 - M3x15 socket head cap screw
 - M3 washer
 - Control Horn #1
 - Ball Linkage
 - Control Horn #2
 - M3 washer
 - M3 locknut

9. With the radio powered on and the servo centered perpendicular to the servo case, adjust the linkage length so that the rudder is centered.

INSTALLING THE VERTICAL FIN

Required for this section

Components

- Vertical fin Assemblies
- Vertical Fin Carbon Fiber Tube
- M3x15 Socket Head Cap Screw (3)
- M3 Washer (3)

Tools

- Hobby Knife with a #11 blade
- #1 Phillips Screwdriver
- 2.5mm Hex Driver

Adhesives/Building Materials

- Blue Thread Lock



1. Insert the carbon fiber vertical fin tube into the appropriate hole in the fuselage until it bottoms out.



2. Partially install the vertical fin on the tube. Rotate the vertical fin on the tube approximately 45 degrees away from its final installed position. Connect the servo lead to the servo extension, and secure it in place using a Servo Connector Safety Clip (FPZA1040). Continue sliding the vertical fin down onto the tube at the 45-degree angle. Once the aluminum tailwheel bracket has passed the notch at the bottom of the fuselage, you can rotate the fin to align it in line with the fuselage. Finish seating the vertical fin fully, being sure to avoid pinching your rudder servo wires.



3. The vertical fin is secured in place by one M3 x 15 socket head cap screw and M3 washer toward the leading edge of the vertical fin, and by two M3 x 10 socket head cap screws and two M3 washers through the tailwheel bracket into the bottom of the fuselage. Secure all three screws in place. If you do not plan on removing the vertical fin, use blue thread lock when securing the screws.
4. Slide the lock collar up to the aluminum tailwheel bracket. Apply blue thread lock to the set screw and fully tighten.

IMPORTANT

The aluminum tail wheel bracket and tailwheel wire are key structural elements and act like a hinge. It is important that these parts are not modified or replaced and that the screws mounting the bracket to the fuselage are not omitted.

Pull/Pull System

Required for this section

Components

- Fuselage Assembly
- Rudder Servo
- 4-inch Double Servo Arm
- Wire Crimps (4)
- Pull-Pull Cable (2)

Tools

- Hobby Knife with a #11 blade
- #1 Phillips Screwdriver

Adhesives/Building Materials

- Thin CA

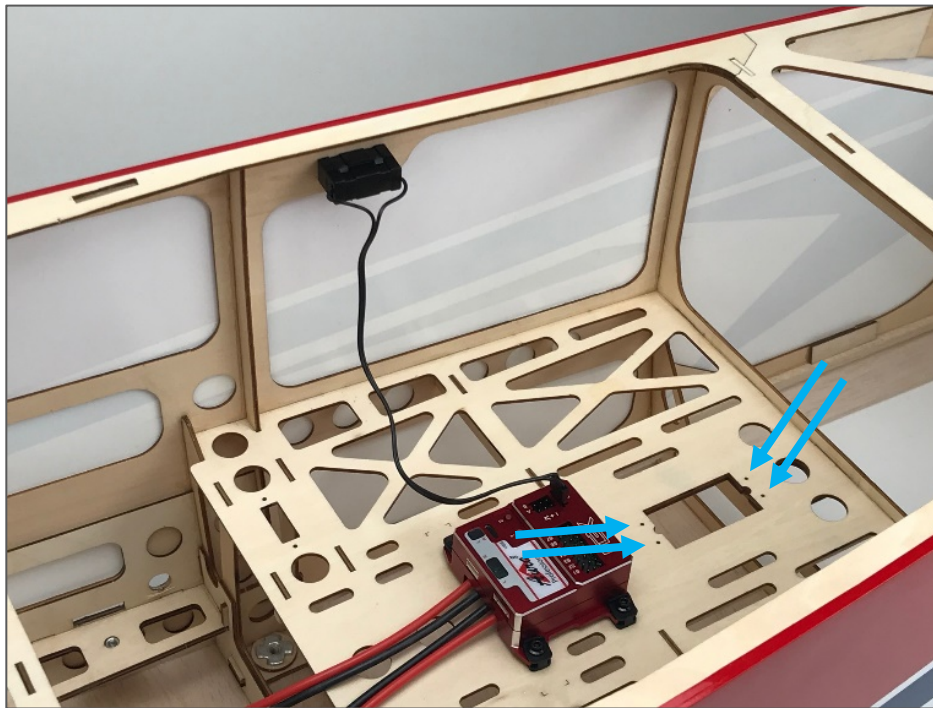

1. Use a #1 Phillips screwdriver to thread a servo mounting screw into each of the pre-cut holes in the servo mounting location on the rudder servo tray inside the fuselage. Remove the screw and apply a small amount of thin CA to each of the holes to harden the threads cut by the screw. Let the CA fully cure before moving forward.
2. Insert the rudder servo into the rudder tray inside the fuselage with the output shaft towards the nose of the airplane. Mount the servo to the tray using the screws provided with your servo.
3. Center the servo using your radio system. Install the 4-inch servo arm so that is perpendicular to the servo case. Apply a small drop of blue thread lock onto the servo arm screw and secure it in place. If you are using a servo arm with clamping screws, apply a drop of blue thread lock and secure them in place.

Quique's Tip:

You may find that the servo arm for pull-pull does not fit close to perpendicular to the servo case. Since the RV-8 70cc FLS does not require a servo arm with an offset for pull-pull, try rotating the arm 180° to see if it fits closer to perpendicular when mounted in this orientation.



4. Locate the pull-pull cable exit holes in the rear of the fuselage. Use a hobby knife with a #11 blade to remove the covering from the hole. The plastic tube guide is located approximately 5-1/4-inches (130mm) from the rudder hinge line (see picture above). The tube should run perpendicular to the rudder hinge line. With the canopy removed and looking from the cockpit towards the tail you will see the nylon tube guides for the cables.



5. Using pliers, thread a rigging coupler approximately halfway into a ball link. Take a section of pull-pull cable and route it through a small piece of heat shrink tubing, followed by a cable crimp. Then route the cable through the rigging coupler and back through the crimp. For extra security, you can loop the cable around the crimp a final time. Slide the crimp tight against the coupler and use a crimping tool to permanently attach the cable. Apply a small amount of thin CA to aid in securing the cable and crimp. Once secure, slide the heat shrink tubing back over the cable and crimp, and shrink it in place. The shrink tubing is only used to keep the cables looking neat and prevent the wire from snagging on any objects. Repeat this process for the second cable side.

6. Thread a rigging coupler approximately one-third of the way into your final two ball links. Secure the ball link and rigging coupler assembly to each side of the rudder servo arm. The order of hardware is as follows:
- M3x15 Socket Head Cap Screw
 - M3 Washer
 - Ball Link (with rigging coupler)
 - Servo Arm
 - M3 Washer
 - M3 Lock Nut

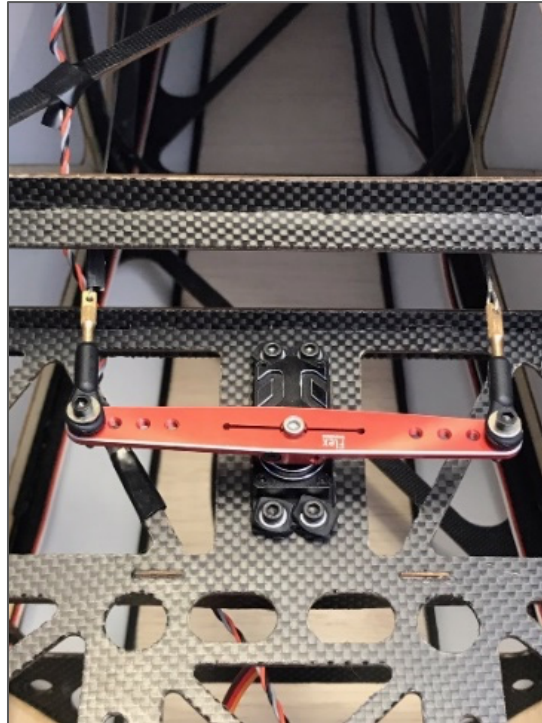

7. Route the pull-pull wire through the fuselage and out the exit holes. Be sure to route the cables so that they do not tangle or cross. The cables should route straight from the servo arm to the exit of the fuselage.
8. Attach the ball link to the rudder control horn using a 2.5mm hex driver and a 5.5mm nut driver. Use the same order of hardware as done with the aileron control horns.
9. Power on your radio system and make sure the control horn is perpendicular to the servo case. Route a cable through a piece of heat shrink tubing, through a crimp and then through the rigging coupler mounted to the servo arm. Route the cable back through the crimp. For extra security, you can loop the cable around the crimp a final time. Repeat for the other pull-pull cable.
10. Pull the cables tight, while keeping the rudder centered. Once happy with the centering of the servo with the cables tight, use a crimping tool to permanently attach the crimp to the cables. Apply a small amount of thin CA to the cable and crimp joint for extra security. Once the CA has fully cured, slide the heat shrink over the joint and shrink it to secure it in place.

11. Adjust final cable tension by removing the ball links and by threading the rigging coupler further into the ball link. Start with the side that was only threaded one-third of the way into the link. Be sure to keep the rudder centered in the process. Do not over tighten the cables.

Quique's Tip:

When new, pull-pull cables will stretch slightly in the first several flights. Adjust the tension as needed until the stretching stabilizes.

Push/Pull System, Servo Installed in Fuselage

Required for this section

Components

- 2-inch Single-Sided Servo Arm
- Ball Link (2)
- M3x15 Socket Head Cap Screw (2)
- M3 Flat Washer (4)
- M3 Lock Nut (2)
- 48-inch (1220mm) Servo Extension
- 4-3/4-inch (120mm) Linkage

Tools

- Hobby Knife with a #11 blade
- #1 Phillips Screwdriver

Adhesives/Building Materials

- Thin CA



1. Locate the rudder servo bays in the rear of the fuselage. They are located approximately 65mm from the bottom of the fuselage, and 117mm from the start of the rudder hinge bevel. Choose which side you wish to mount the servo to and use a hobby knife with a fresh #11 blade to remove the covering, leaving approximately 1/8-inch (3mm) extra covering over the inside of the pocket. Use a covering or trim iron to seal the covering into the slot.

2. Use a #1 Phillips screwdriver to thread a servo mounting screw into each of the pre-cut holes in the servo mounting rails. Remove the screw and apply a small amount of thin CA to each of the holes to harden the threads cut by the screw. Let the CA fully cure before proceeding.



3. Attach a 48-inch (1220mm) servo extension to the servo. Use a Servo Connector Safety Clip (FPZA1040), thread or heat shrink tubing to secure the extension in place. Route the servo extension through the holes in the formers as shown in the picture above.
4. Install the servo into the pocket with the output shaft toward the rear of the airplane.
5. Power on your radio system to center the servo. Install a 2-inch (51mm) servo arm onto the servo. Apply a small amount of blue thread lock to the servo arm screw and secure it in place. If your servo arm has clamping screws, apply blue thread lock to these screws and secure them in place. Note that you may need to power off the model and rotate the servo arm by hand to have access to each screw.
6. Using a pushrod 4-3/4-inches (120mm) long, assemble the rudder linkage so that the total length from center of ball to center of ball is approximately 5.7-inches (145mm). Final length will be adjusted once the linkage has been attached to the servo and control horn.
7. Attach the linkage to the servo arm. The correct hole location is 2-inches (51mm) from the center of the servo arm. If you are using the recommended servo arm, this is the outermost hole. The order of hardware components, starting from the top of the servo is as follows:
- M3x15 socket head cap screw
 - M3 washer
 - Ball Linkage
 - Servo Arm
 - M3 washer
 - M3 locknut

8. Attach the linkage to the control horn. The order of hardware components, starting from the tip of the rudder is as follows:
- M3x15 socket head cap screw
 - M3 washer
 - Control Horn #1
 - Ball Linkage
 - Control Horn #2
 - M3 washer
 - M3 locknut
9. With the radio powered on, make any final adjustments to the linkage length to center the rudder accordingly.

MOUNTING THE STAB

Required for this section

Components

- Carbon Fiber Horizontal Stabilizer Tube
- Left and Right Horizontal Stabilizers
- M3x15 Socket Head Cap Screw (4)
- M3 Washer (4)
- 48-inch (1220mm) elevator extensions (2)

Tools

- Hobby Knife with a #11 blade
- #1 Phillips Screwdriver
- 2.5mm Hex Driver

Adhesives/Building Materials

- Thin CA
- Blue Thread Lock



1. Route the (2) 48-inch (1220mm) elevator servo extensions through the holes in the corners of the formers to keep them from bouncing around inside the fuselage. Place the female end of the servo extension in the retention slot cutout at the exit of the fuselage. This will prevent the extension from falling back into the fuselage.

2. Insert the carbon fiber horizontal stab tube into the appropriate hole in the fuselage and approximately center it left and right. Slide the left horizontal stabilizer onto the carbon tube and route the servo extensions further through the fuselage.

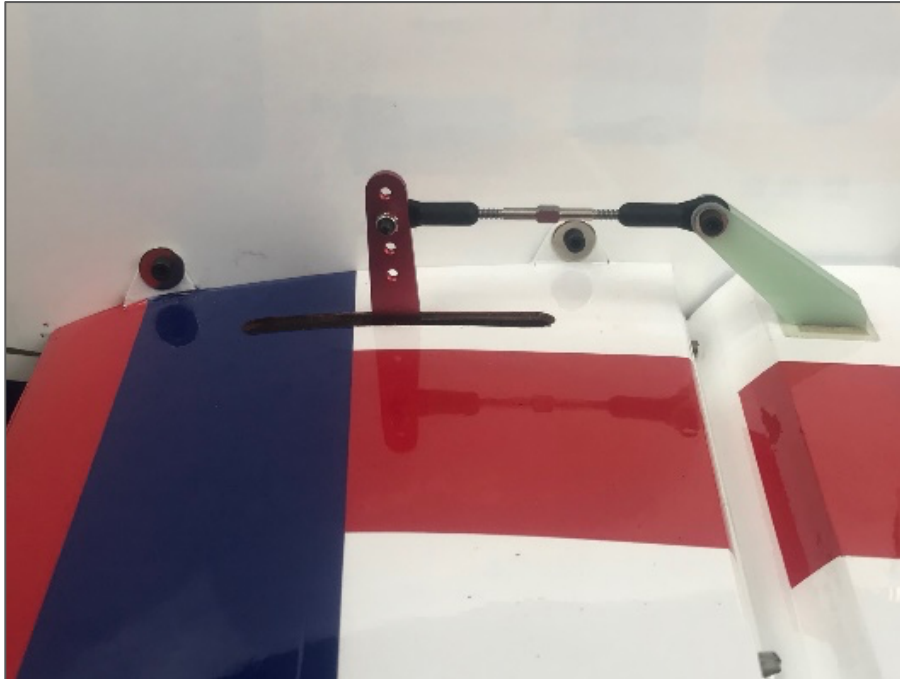

3. Use a 2.5mm hex driver to secure (2) M3x15 socket head cap screws and (2) M3x12 flat washers in place.
4. Repeat steps 2 and 3 for the right horizontal stabilizer.

LANDING GEAR INSTALLATION

Required for this section

Components

- Fuselage Assembly
- Wheel Pant (2, L & R)
- Main Wheel (2)
- M4x25 Socket Head Cap Screw (4)
- M4 Flat Washer (2)
- M4 Lock Nut (6)
- M3x15 Socket Head Cap Screw (4)
- M3 Flat Washer (4)
- Landing Gear Axle (2)
- M5 Lock Collar (4)

Tools

- 1.5mm Hex Driver
- 2.5mm Hex Driver
- 3mm Hex Driver
- Small Flat File
- 7mm Wrench
- 10mm Wrench
- 13mm Wrench
- Needle Nose Pliers (optional)

Adhesives/Building Materials

- Blue Thread Lock



1. Assemble the axle to the landing gear leg. Use one 5mm flat washer between the lock nut and the landing gear leg as shown above. Fully tighten using a 10mm and 13mm open end wrench.



2. Temporarily slide a lock collar fully onto the axle, and space it 2mm (3/32-inch) off the axle flange. Secure it in place with a 1.5mm hex driver. Slide a wheel onto the axle, followed by a second wheel collar, securing it in place by a 1.5mm hex driver. Use a felt-tipped pen to place a mark on the inside edge of the inner lock collar and the outside edge of the outer lock collar. Remove both lock collars and the wheel from the axle.

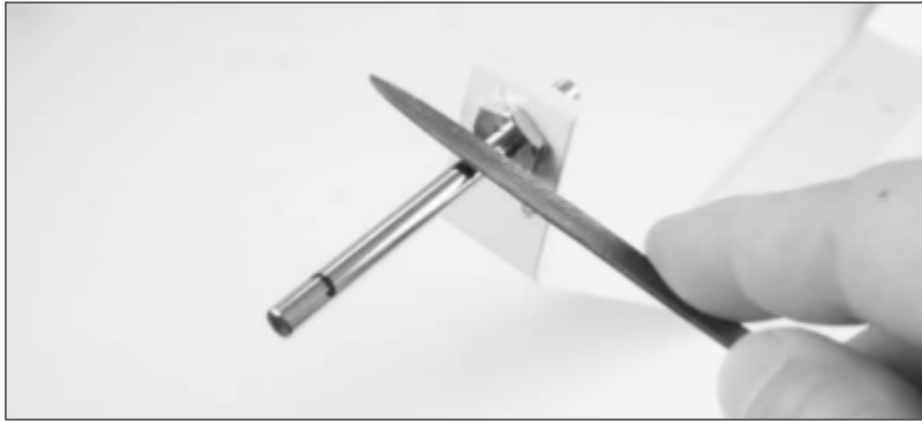

- 3. Use a flat file to make two flat spots on the axle for the wheel collar set screws to tighten against, noting the marks from the previous step. Keep in mind that the marks made were on the outside edge of the collar, not the center so you will need to offset your file from these marks. Do not remove a lot of material as it will weaken the axle. You only need a small flat spot for each set screw.
- 4. Re-assemble the lock collars and wheel as done in step one. Use blue thread lock on the set screw and tighten the lock collar down. Be sure to orient the collars so that the side with the smallest diameter faces the wheel. Ensure that the wheel spins freely after everything has been tightened.

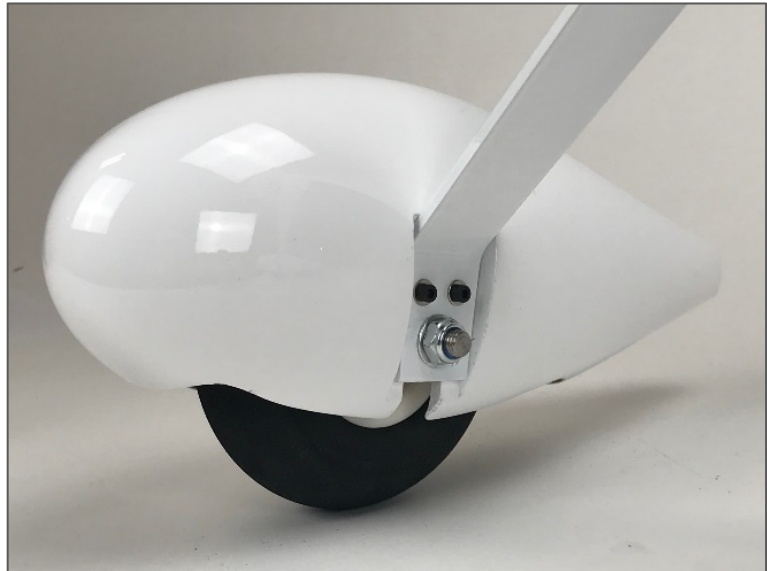

- 5. Install the wheel pants using a 2.5mm hex driver, two M3x15 socket head cap screws and two M3 washers. Apply blue thread lock to the screws before securing them in place.

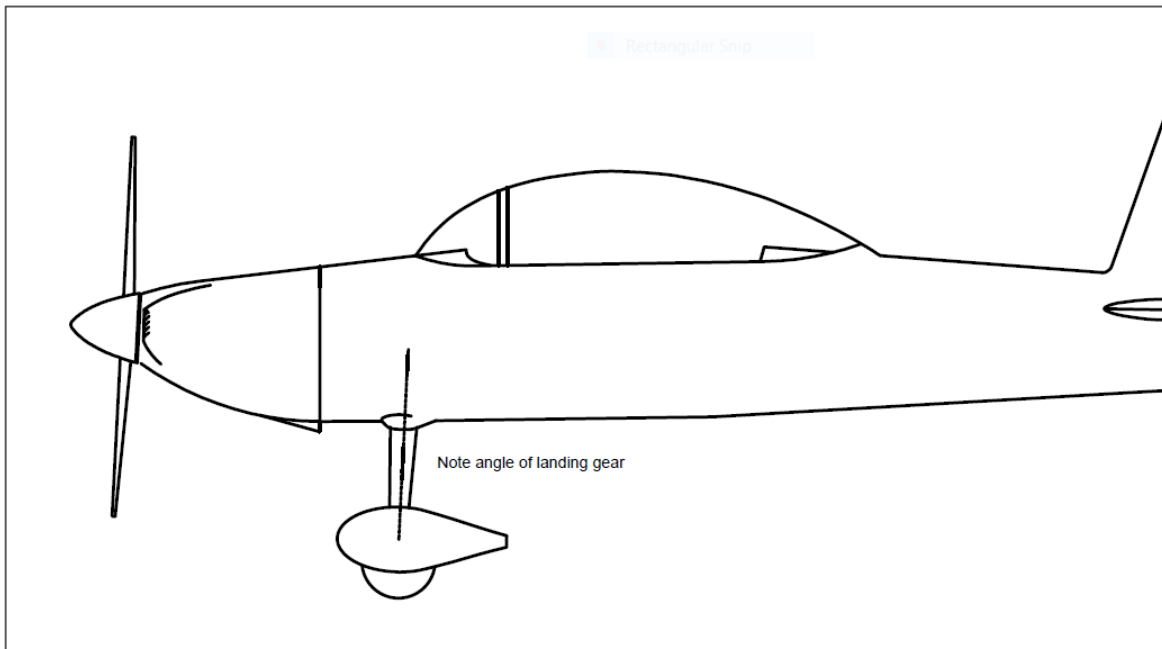

6. Be sure to note that the landing gear sweeps forward as it moves away from the fuselage. The wheel pant mounting holes are specific to a side.



7. With the fuselage inverted on your workspace, place the landing gear on the fuselage so that it sweeps forward as it moves away from the fuselage. Place an M4x25 socket head cap screw with an M4 washer through the landing gear and through the landing gear mount in the fuselage. Note that there are not threads in the aluminum angle mount in the fuselage. Place an M4 washer over the screw, followed by an M4 lock nut. You may need to use needle nose pliers to access the screws more easily from inside the fuselage. Tighten the screws using a 3mm hex driver and an 7mm open end wrench. Do not fully tighten until all four M4 screws are in place, and the M4 lock nuts have been started.

ENGINE AND THROTTLE SERVO INSTALLATION

The RV-8 70cc FLS is designed for 50-60cc single cylinder engines, or twin 70-76cc engines. This manual will cover the installation of the DA-70 and the DA-60.

DA-70 ENGINE INSTALLATION

Required for this section

Components

- Fuselage Assembly
- Engine
- Engine Standoffs (20mm)
- 1/4-20 Blind Nut (4)
- 1/4-20 x 1-1/2-inch Socket Head Screw (4)
- 1/4-inch flat washer (4)

Tools

- Drill
- 1/8-inch (3mm) Drill Bit
- 5/16-inch (8mm) Drill Bit
- 1/4-inch Hex Driver

Adhesives/Building Materials

- Blue Thread Lock



1. Remove the plywood structure on the fuselage, just below the motor box and behind the throttle servo mounting location by pushing with your fingers. If this does not push out easily, you can trace the shape with a sharp #11 hobby knife to make it easier to remove. Regardless of the exhaust system used, this must be removed for proper cooling.



2. The engine mounting locations for the DA-70 is laser-etched into the firewall for your convenience. If using a different mounting pattern, the "+" represents the engine crankshaft. Use a 1/8-inch drill bit and drill to create a pilot hole in the center of the four bolt hole etchings in the firewall. Use a 5/16-inch drill bit to enlarge these holes. Verify that the hole is large enough to accommodate the blind nuts which will be installed in the step 4.
3. Using CA, install the (4) 3mm plywood washers.
4. Use a 1/4-20 x 1-1/2-inch screw, 1/4-inch flat washer, and 20mm standoff to pull the blind nut into the back side of the firewall. Once fully seated, you may apply some medium CA to help secure the blind nut. Ensure that you don't get any adhesive on the threads of the blind nut. Let the CA fully cure before moving to the next step.
5. Mount the engine (without the exhaust) to the firewall using (4) 20mm engine standoffs, (4) 1/4-20 x 1-1/2-inch socket head cap screws and (4) 1/4-inch flat washers. Be sure to apply blue thread lock to the motor mount screws. The order of components is as follows:
 - 1/4-20 x 1-1/2-inch Socket Head Cap Screw
 - 1/4-inch flat washer
 - Engine
 - 20mm Engine Standoffs
 - Firewall
 - 1/4-20 Blind Nut

DA-70 Throttle Servo and Throttle Linkage Installation

Required for this section

Components

- Fuselage Assembly
- Throttle Servo
- 18-inch (460mm) Servo Extension
- Safety Servo Clip Connector
- 2mm White Ball Link
- M2x10 Phillips Head Screw (1)
- M2 Flat Washer (2)
- M2 Lock Nut (1)

Tools

- #1 Phillips Screwdriver
- 2.5mm Hex Driver

Adhesives/Building Materials

- Thin CA
- Blue Thread Lock

1. Attach the 18-inch (460mm) servo extension to the throttle servo. Use a Servo Connector Safety Clip (FPZA1040), thread or heat shrink tubing to secure the extension in place.

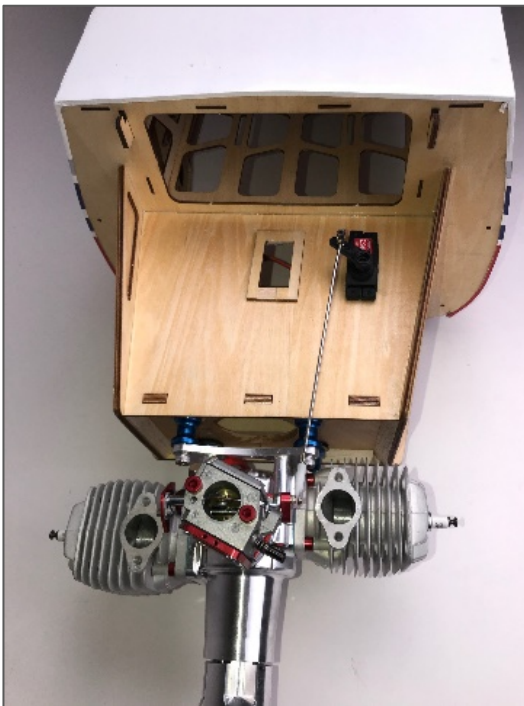

2. There are two options for the servo tray. The middle location is normally used when stock mufflers are used. The one to the side of the motor box is used when canisters are used. Install the throttle servo with the output shaft towards the nose of the aircraft.

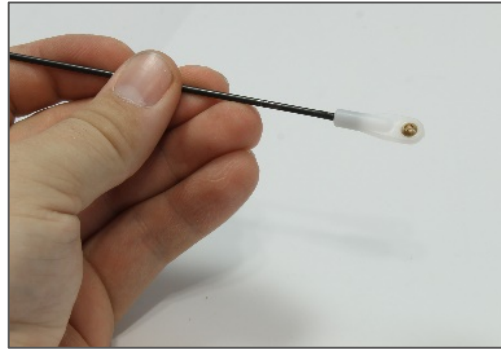

3. Use the radio system to center the servo, then install a 1-inch (25mm) servo arm onto the servo. If you used the middle location, make sure the servo arm is oriented to the side of the fuselage that provides the straightest geometry to the throttle arm on the engine. If a canister is used, orient the servo arm towards the centerline of the fuselage to provides the straightest geometry to the throttle arm on the engine. Do not secure the servo arm screw currently.
4. Secure the quick connector to your servo arm. Be sure to use blue thread lock for a secure attachment. The order of components is as follows:
 - Quick connect housing
 - Washer
 - Servo Arm
 - Washer
 - Nut
5. Locate the pushrod that is only threaded at one end. Thread this linkage approximately halfway into a WHITE ball linkage. Secure the ball link to your engine throttle arm using the 2 x 10mm screw, 2mm washers (2), and 2mm lock nut. Do not use thread lock on these parts, as it can weaken the plastic insert in the lock nut. The order of these components should be:
 - Screw
 - Washer
 - Throttle Arm
 - Washer
 - Lock Nut.
6. Remove the M3x5 socket head cap screw from the quick connect. Insert the non-threaded portion of the throttle linkage through the hole in the side of the quick connect. With the radio powered on, center the throttle servo and engine throttle arm. Use blue thread lock and secure the M3x6 screw onto the linkage. Check throttle movement and position relative to stick position and make any changes necessary. Fully tighten the screw.

Quique's Tips:

- Use the shortest servo arm possible while still getting full throttle arm movement on your engine. Your throttle end points should be around 110-120% when finished with the installation. A faster servo (like the Potenza DS22209HV) with a shorter arm is preferred over a slower servo with a longer arm.

Quique's Tips (continued):

- For the most linear throttle response, adjust the throttle linkage length to balance the end points for your throttle servo. You do NOT want your end points to be mismatched (example: 60/120). Get your end points as close to one another as possible (example: 114/116) for the most linear throttle response.

DA-60 ENGINE INSTALLATION

Required for this section

Components

- Fuselage Assembly
- Engine
- Engine Standoffs (30mm)
- 1/4-20 Blind Nut (4)
- 1/4-20 x 1-1/2-inch Socket Head Screw (4)
- 1/4-inch flat washer (4)

Tools

- Drill
- 1/8-inch (3mm) Drill Bit
- 5/16-inch (8mm) Drill Bit
- 1/4-inch Hex Driver

Adhesives/Building Materials

- Blue Thread Lock



1. Remove the plywood structure on the fuselage, just below the motor box and behind the throttle servo mounting location by pushing with your fingers. If this does not push out easily, you can trace the shape with a sharp #11 hobby knife to make it easier to remove. Regardless of the exhaust system used, this must be removed for proper cooling.
2. The engine mounting locations for the DA-60 is laser-etched into the firewall for your convenience. If using a different mounting pattern, the "+" represents the engine crankshaft. Use a 1/8-inch drill bit and drill to create a pilot hole in the center of the four bolt hole etchings in the firewall. Use a 5/16-inch drill bit to enlarge these holes. Verify that the hole is large enough to accommodate the blind nuts which will be installed in the next step.

3. Use a ¼-20 x 1-1/2-inch screw, ¼-inch flat washer, and 30mm standoff to pull the blind nut into the back side of the firewall. Once fully seated into the firewall, you may apply some medium CA to help secure the blind nut. Ensure that you don't get any adhesive on the threads of the blind nut. Let the CA fully cure before moving to the next step.

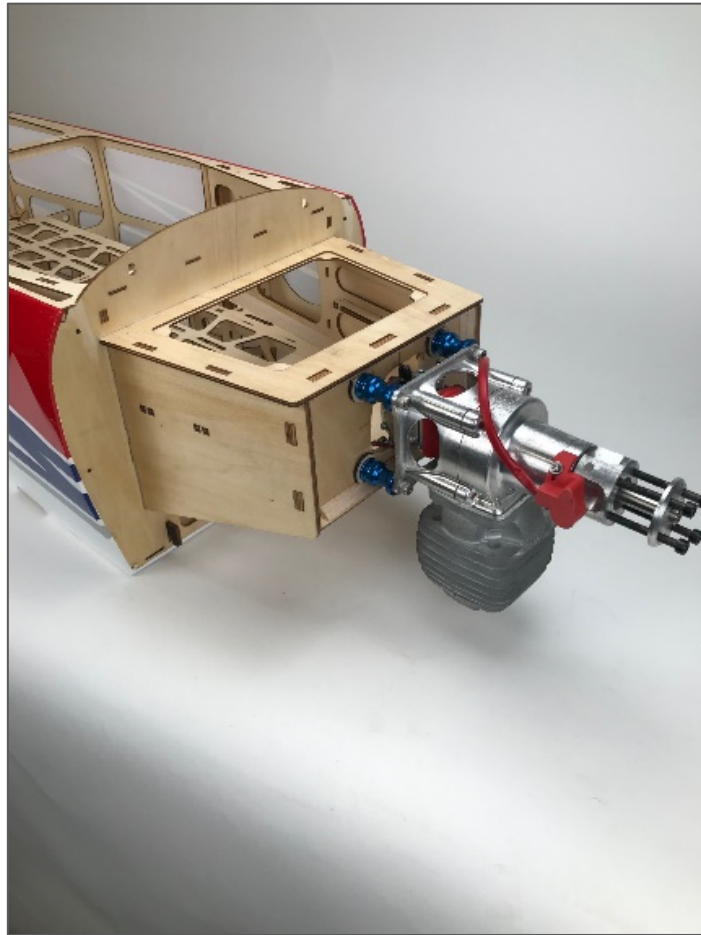

4. Mount the engine (without the exhaust) to the firewall using (4) 30mm engine standoffs, (4) ¼-20 x 1-1/2-inch socket head cap screws and (4) ¼-inch flat washers. Be sure to apply blue thread lock to the motor mount screws. The order of components is as follows:
- ¼-20 x 1-1/2-inch Socket Head Cap Screw
 - ¼-inch flat washer
 - Engine
 - 30mm Engine Standoffs
 - Firewall
 - ¼-20 Blind Nut

Throttle Installation

Required for this section

Components

- Fuselage Assembly
- Throttle Tray
- Throttle Servo
- choke servo (optional)
- 18-inch (460mm) Servo Extension
- 2mm White Ball Link
- M2x10 Phillips Head Screw (1)
- Safety Servo Clip Connector
- M2 Flat Washer (2)
- M2 Lock Nut (1)
- 2mm wood servo screw (4)

Tools

- #1 Phillips Screwdriver
- 2.5mm Hex driver

Adhesives/Building Materials

- Blue Thread Lock
- Epoxy or CA

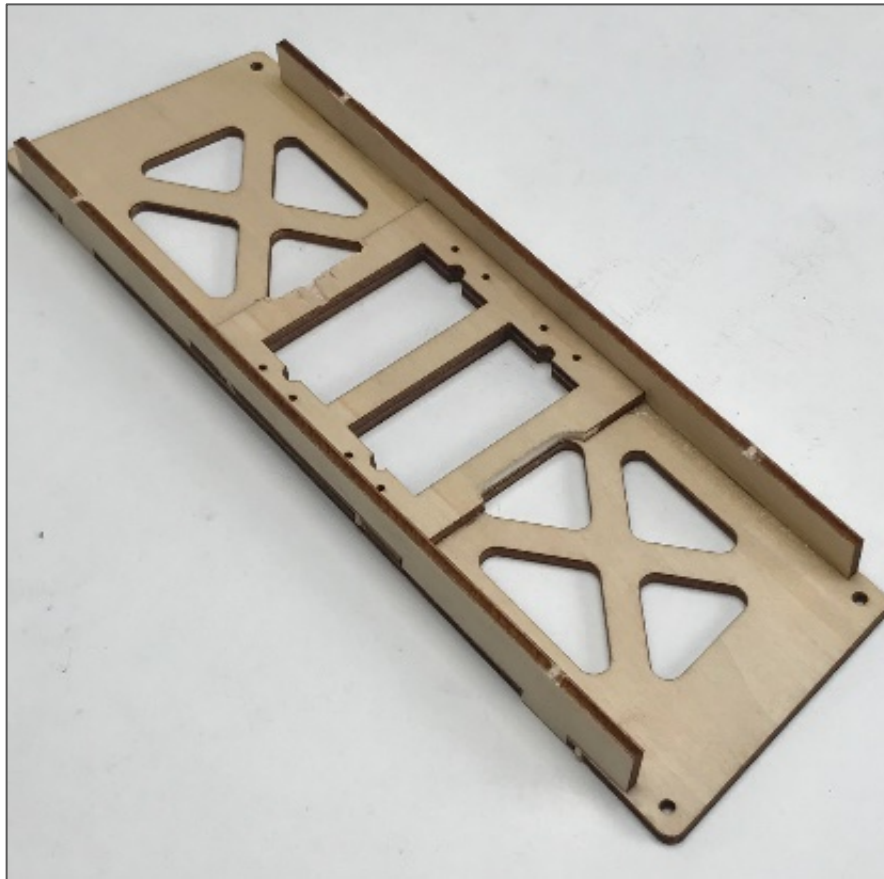

1. Using CA or epoxy, build the DA-60 servo tray as shown in the picture above.



- 2. Using CA, take two mounting rails and glue them together to double their thickness. Once dry, use 30-minute epoxy to glue each set of rails to the sides of the motor box.
- 3. Attach the 18-inch (460mm) servo extension to the throttle servo. Use a Servo Connector Safety Clip (FPZA1040), thread or heat shrink tubing to secure the extension in place.



- 4. When viewing the aircraft as if you were the pilot, install the servo right side up on the left side of the tray as shown in the picture. Optionally, you can mount the choke servo upside down and on the right side of the tray. NOTE: The throttle and choke servo can be mounted in any orientation desired. It is preferred, however, to mount the servo with the output shaft toward the nose of the aircraft.

5. Secure the tray in place using (4) M2.5x8 self-tapping screws and a #1 Phillips screwdriver in the location shown in the picture in Step 4.

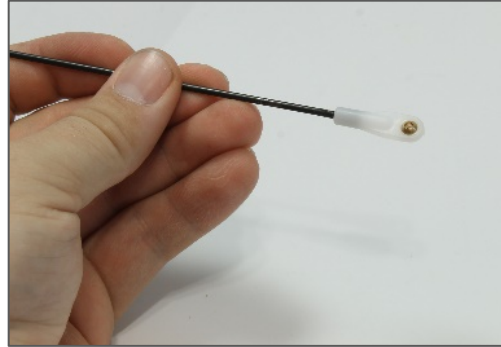

6. Use the radio system to center the servo, then install a 1-inch (25mm) servo arm onto the servo. Make sure the servo arm is oriented to the side of the fuselage that provides the straightest geometry to the throttle arm on the engine. Do not secure the servo arm screw currently.
7. Secure the quick connector to your servo arm. Be sure to use blue thread lock for a secure attachment. The order of components is as follows:
- Quick connect housing
 - Washer
 - Servo Arm
 - Washer
 - Nut
8. Locate the pushrod that is only threaded at one end. Thread this linkage approximately halfway into a WHITE ball linkage. Secure the ball link to your engine throttle arm using the 2 x 10mm screw, 2mm washers (2), and 2mm lock nut. Do not use thread lock on these parts, as it can weaken the plastic insert in the lock nut. The order of these components should be:
- Screw
 - Washer
 - Throttle Arm
 - Washer
 - Lock Nut.
9. Remove the M3x5 socket head cap screw from the quick connect. Insert the non-threaded portion of the throttle linkage through the hole in the side of the quick connect. With the radio powered on, center the throttle servo and engine throttle arm. Use blue thread lock and secure the M3x6 screw onto the linkage. Check throttle position relative to stick position and make any changes necessary. Fully tighten the screw.

Quique's Tips:

- Use the shortest servo arm possible while still getting full throttle arm movement on your engine. Your throttle end points should be around 110-120% when finished with the installation. A faster servo (like the Potenza DS22209HV) with a shorter arm is preferred over a slower servo with a longer arm.

Quique's Tips (continued):

- For the most linear throttle response, adjust the throttle linkage length to balance the end points for your throttle servo. You do NOT want your end points to be mismatched (example: 60/120). Get your end points as close to one another as possible (example: 114/116) for the most linear throttle response.

IGNITION INSTALLATION

Required for this section

Components

- Fuselage Assembly
- Ignition
- Ignition Switch
- Ignition Battery
- Regulator (if applicable)

Tools

- Hobby Knife w/#11 Blade

Adhesives/Building Materials

- Hook and Loop Strap (2)
- Adhesive-Back Hook and Loop Tape

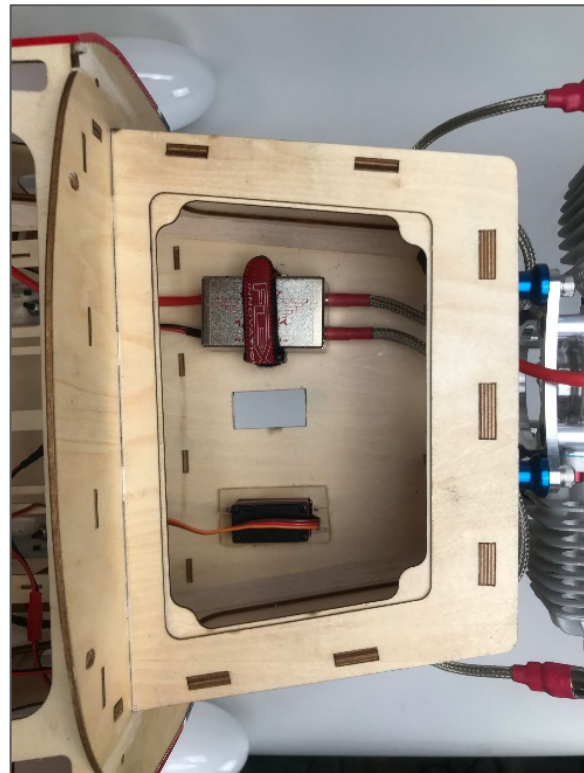

- 1. Locate the ignition switch hole towards the nose of the fuselage. Note that there are switch locations on both sides of the fuselage for your preference. Use a hobby knife with a #11 blade to remove the covering from the hole of your choice. Test fit your switch and modify the hole if needed. Secure it in place using the screws included with your switch. If your switch mounting screws thread into metal, be sure to apply blue thread lock. DO NOT apply blue thread lock if they thread into plastic.

2. The ignition can be mounted wherever you prefer. We have found that with the DA-60/70 the above depicted location works well. There are many ways to install an ignition and we recommend you mount it per your engine manufacturer's instructions.



3. Once you've decided where to mount the ignition, you need to make 2 slots for the hook and loop straps to pass through the motor box. Use a felt-tipped pen to mark each side of the ignition you want the strap to pass through. Use a rotary tool with a cutoff wheel (or rotary bit of your choice) to make the slots in the motor box. Keep these slots as small as possible to prevent weakening the motor box.

Quique's Tip:

- Over the years, I have found that the below described system provides a solid mounting platform, while still providing enough dampening from vibration. Mount as you prefer, but this works very well and is a proven method for a long-lasting mounting solution:
- Cut a piece of ¼-inch (6mm) thick, soft foam the same size as the ignition box. Apply adhesive-backed hook and loop tape on the ignition and both sides of the foam rectangle. Stick the foam to the ignition. Apply another piece of adhesive-backed hook and loop tape to the motor box where you will mount the ignition. Make sure it is the opposite type when compared to the hook and loop on the ¼-inch foam. Stick the ignition and foam assembly to the motor box and strap it to the motor box using hook and loop strap. Tighten the strap around the ignition so that it is firm and relatively tight. Don't over-tighten as you do want some vibration dampening effect from the foam.

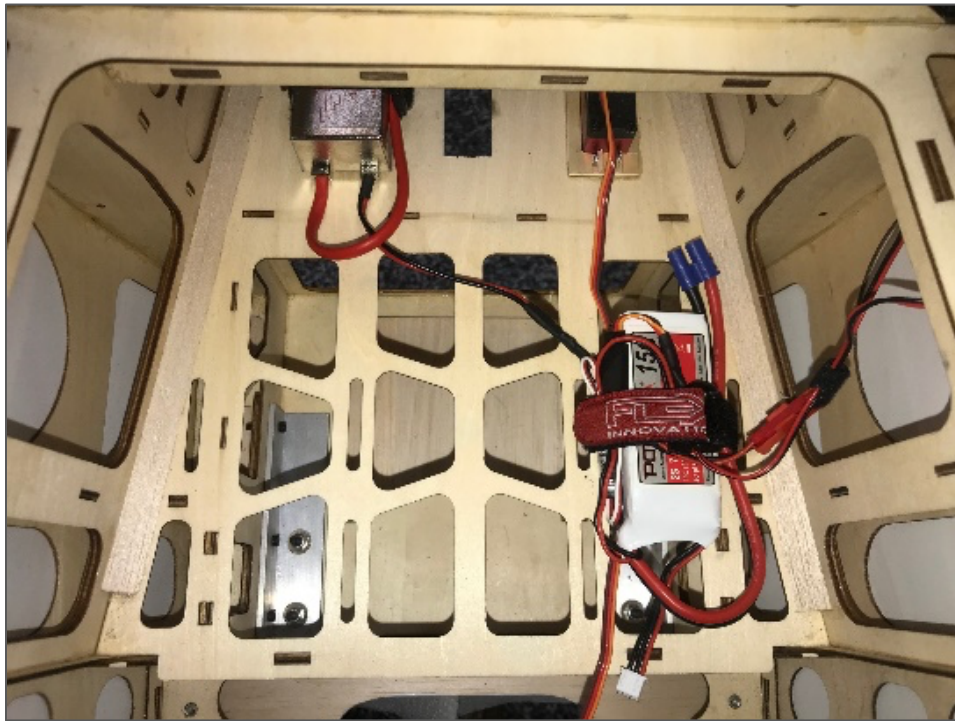

- 4. Place your ignition battery inside the fuselage as shown in the above picture. Use adhesive-backed hook and loop tape between the battery and the fuselage and secure the battery with a hook and loop strap.
- 5. Route all your wiring and make all electronic connections at this time. Secure any permanent connections with Servo Safety Clips (FPZA1040). Be sure to secure the wiring so that it will not bounce around in the aircraft. Also, be sure to secure the wiring in a way the wires will not chafe over time from vibration. A typical ignition setup will be connected as follows:

Ignition Battery → Ignition Switch → Ignition Regulator → Ignition → Engine

FUEL TANK INSTALLATION

Required for this section

Components

- Fuselage Assembly
- Fuel Tank
- Fuel Line

Tools

- Pliers

Adhesives/Building Materials

- Hook and Loop Strap (2)
- Adhesive-Back Hook and Loop Tape

The Flex Innovations Lightweight 24oz Fuel Tank is included with your RV-8 70cc FLS. Before installing the fuel tank check all fittings are properly installed and that the clunk line inside the tank is appropriately sized.

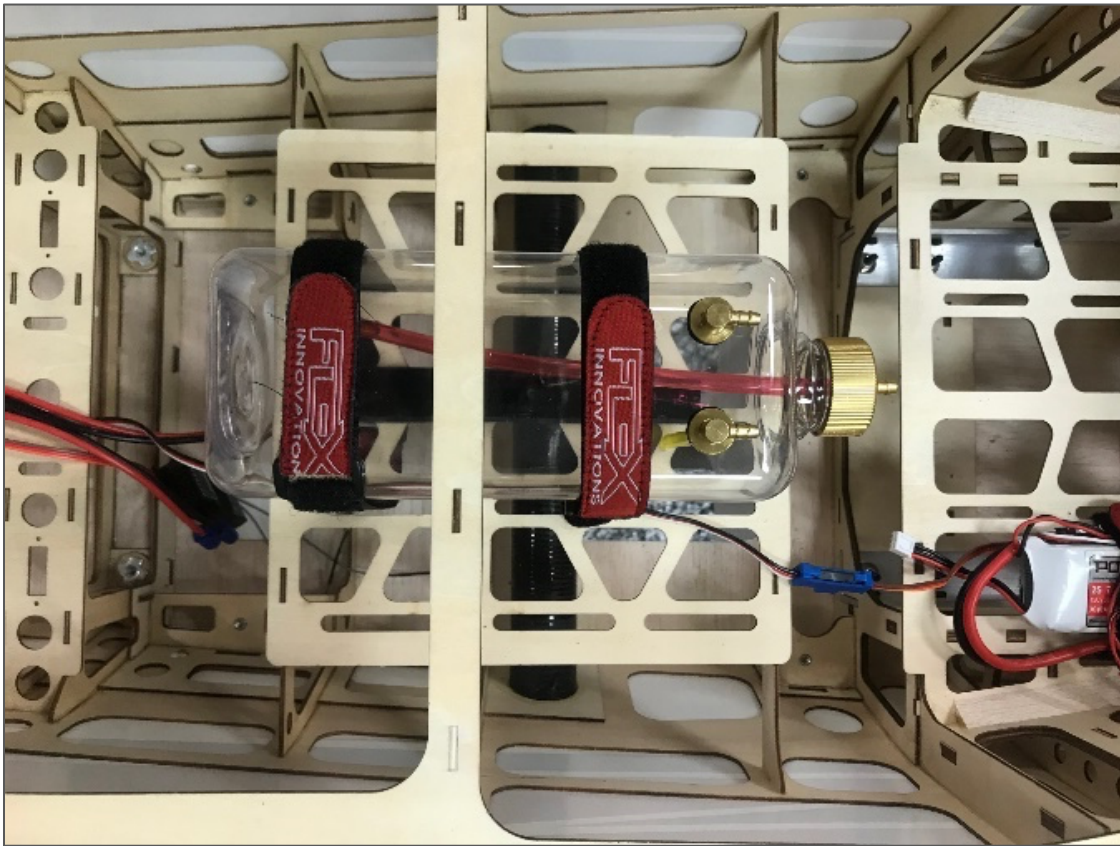

1. The fuel tank tray has plenty of room for your fuel tank. If you are using a single tank, you can place the fuel tank in the middle of the tray as shown in the image above. The image above shows the optional 32oz Lightweight Fuel/Smoke tank (FPM1623). If you plan on using a smoke system, two of the 24oz Lightweight Fuel/Smoke tanks (FPM2019) should be used. One is included in your kit.

Apply adhesive-backed hook and loop tape to the bottom of your tank(s) and to the fuel tank tray. Place the tank(s) in their location and secure them with two hook and loop straps. These straps should be snug but not overly tight, as the fuel tanks are very lightweight and can be easily crushed. The hook and loop tape on the bottom of the tank(s) will prevent the tank from moving fore and aft, and the hook and loop straps will prevent the tank from pulling away from the tray.

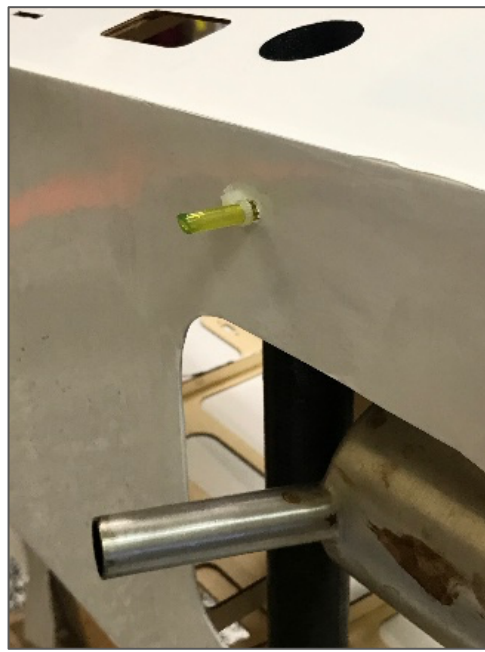
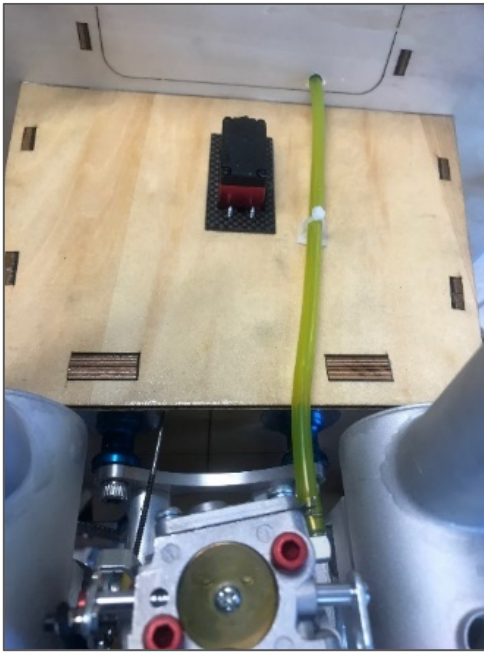

2. After the tank is in position, route and trim your fuel lines appropriately. Your clunk line should go to the carburetor or throttle body. The fill line should go to your fuel dot or filling system. We recommend the McFueller Fuel Dot (FPMAMCFUELER). The vent line should wrap around the back of the tank(s) and pass back in front of the tank(s). It should then exit the bottom of the fuselage as shown in the image above. After the vent line exits the fuselage, use a cable tie around the fuel line to prevent it from slipping back into the fuselage. Don't over-tighten the cable tie, as air and fuel will need to vent from this line. Be sure to keep your fuel line away from components that get hot (like your exhaust or cylinder heads) and route it in such a way that it will not bounce around or chafe on any of the interior structure of the fuselage.

EXHAUST AND COWLING INSTALLATION

Required for this section

Components

- Fuselage Assembly
- Cowling
- Cowling Baffles
- Muffler (or Canisters/Headers)
- Exhaust Gasket (2)
- M3 x 15 Socket Head Cap Screw (4)
- M3 Flat Washer (4)
- M2.5 x 8 Wood Screw
- Motor Box Cover Plate

Tools

- 2.5mm Hex Driver
- #1 Phillips Screwdriver
- Rotary Tool
- Rotary Tool Sanding Drum
- Felt-Tipped Pen

Adhesives/Building Materials

- Colored Silicone (Red typically preferred)
- Thin CA
- Medium CA
- CA Accelerator

If you plan to use stock mufflers, please follow the instructions (A) below. If you plan on using canisters, please follow canister instructions (B) on the following pages. Be sure to follow the engine baffling instructions for both setups.

Muffler Installation (A)

- 1. Install the muffler on the engine using the hardware provided with your engine. Follow your engine manufacturer's installation instructions. Typically, most engines will use a gasket between the muffler and cylinder and the socket head cap screws will pass through a lock washer before securing the muffler to the cylinder.



2. Every engine and muffler choice will require different openings in the cowling. The picture above shows a DA-70 with DA mufflers. Other engine brands, single cylinder engines or other mufflers will require a different cut out. Use a rotary tool with a sanding drum to cut the holes. Test fit the cowling to be sure there is adequate gap between the muffler and cowling. We recommend at least 1/8-inch (3mm) gap.



3. Open the rear "lip" in the bottom rear of the cowling with a sanding drum or a rotary tool as shown in the image above. Be sure to leave approximately 3mm (1/8-inch) of vertical area to maintain strength in the cowling. Be sure to keep the corners round to help prevent cracking.

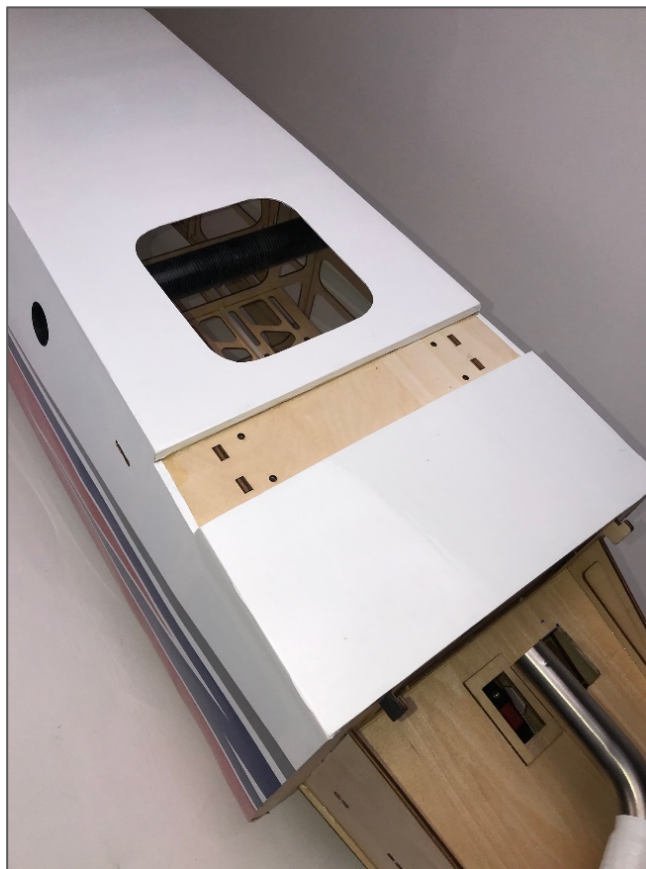

4. For the fuselage exit hole, use a hobby knife with a #11 blade to open the rectangular hole in the bottom of the fuselage. Be sure to leave about 1/8-inch (3mm) overlap so that you can iron the covering to the sheeting on the inside of the fuselage. You may need to cut a few slits in the edge of the covering due to the curved shape of the holes. Apply some epoxy to the edges of the covering to help prevent oil and debris from getting under the covering.

Canister Installation (B)

Recommended canister and headers for the different engines are listed in the front section of the manual.

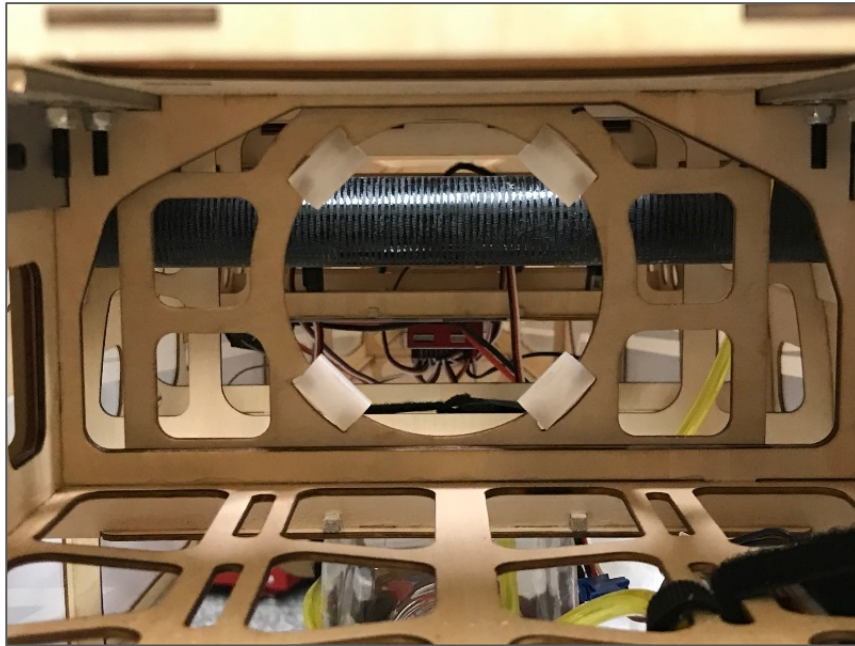

1. Install the exhaust on the engine using the hardware provided with your engine. Follow your engine manufacturer's installation instructions. Typically, most engines will use a gasket between the muffler and cylinder and the socket head cap screws will pass through a lock washer before securing the muffler to the cylinder.



2. Place the mount in the location shown in the image above. Do not glue it in place at this time. Install the header and canister per your engine and exhaust manufacturer's instructions, placing the exhaust through the mount. Once the exhaust is mounted to the engine, use 30-minute epoxy to secure the canister mount in place.

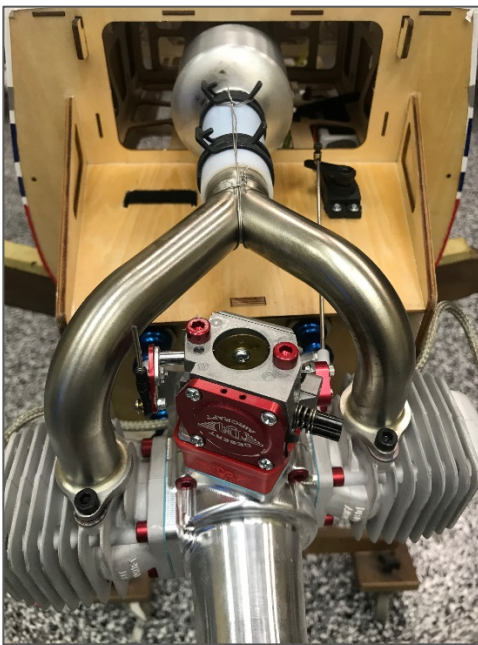

3. The images above show the typical DA-70 with a 2 to 1 header for a single canister. The header has been cut short by 28mm (1-3/32 in) in length to fit appropriately. The header has been cut 28mm to fit the length. Note that during testing, Quique was very pleased with the engine performance, even though the header was trimmed.

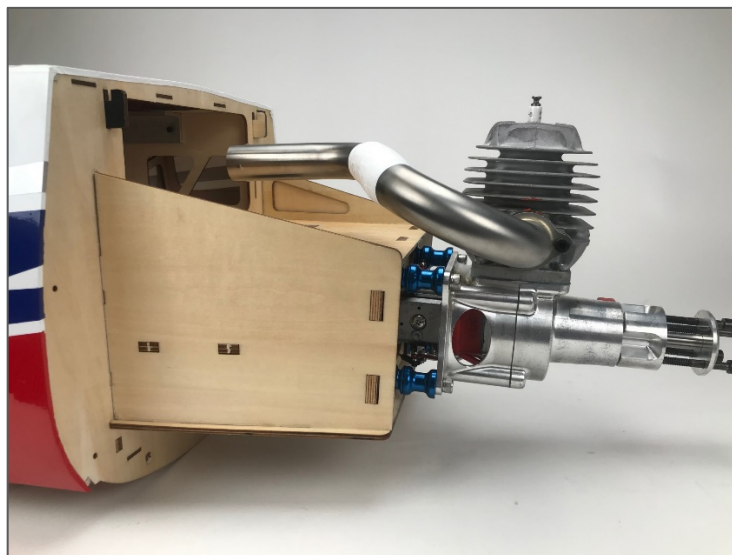
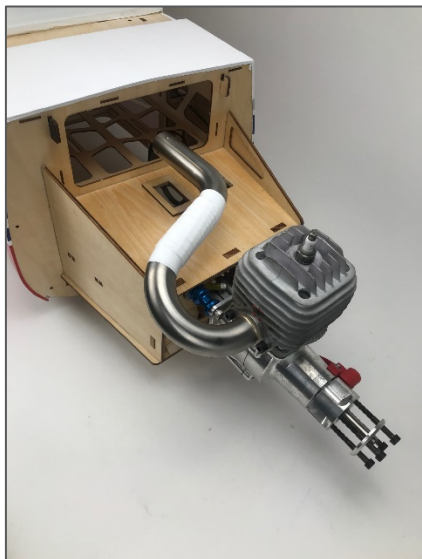

4. The images above show the DA-60 with header for a canister install.



5. Every engine and exhaust choice will require different openings in the cowling. The images above show a DA-70 with 2 to 1 header install. Use a rotary tool with a sanding drum to cut the holes.

Baffle and Final Cowling Installation



1. Locate the engine baffles. These are designed to fit the DA-70 The baffles are labeled according to their locations. The lettering should face the outside of the baffles when assembled.

L = Left Baffle
R = Right Baffle.



2. Using medium CA, build the baffles as shown in the image above. Each piece has markings that should assist you in assembly. On the corner of each baffle is two letters. Match the letters for the proper assembly. Note the lettering should face to the outside of the baffles.

Once assembled and the CA has fully cured, you can paint the baffles with enamel-based paint to help with appearance and help resist damage from fuel or oil. There may be some final tuning required. If you are using a different engine, you can use these as a template or modify them as necessary.

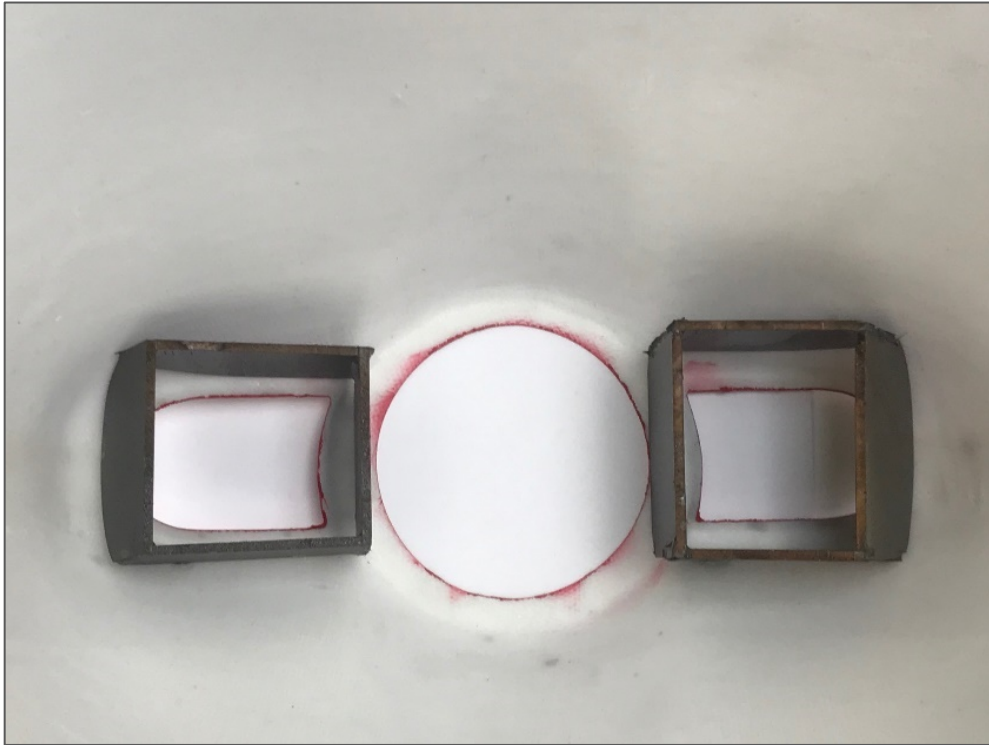

3. Using medium CA, tack each of the baffles into position. The longer baffle goes in the right-hand side of the cowling. Install the cowling and see if any adjustments are needed for any interference with the engine. Using colored silicone (we use black so that it matches the baffling paint), cover all the joints on the inside of the cowling to permanently fix it in place. Let the silicone cure per the manufacturer's recommendations. We choose to use silicone due to the high vibration in this area. Set aside and let it dry for at least for at least 12 hours to fully cure.

4. Install the manual choke linkage using your preferred method. You could use a 2mm ball link and 2mm linkage found on many 60-class ARF or ARFSV aircraft. We leave the pushrod long until the cowling is installed and then trim it for the proper length. Be sure to make a hole in the cowling for the rod and use a grommet or piece of fuel tubing to serve as a guide for the rod and help prevent any wear to your cowling.



5. Locate the motor box top plate and the (4) M2.5 x 8 wood screws. Use a #1 Phillips screwdriver to thread an M2.5 x 8 screw into each of the pre-cut holes in the motor box for the top plate. Remove the screw and apply a small amount of thin CA to each of the holes to harden the threads cut by the screw. Let the CA fully cure before proceeding.
6. Secure the top plate in place using a #1 Phillips screwdriver.
7. Before installing the cowling, verify that all spark-plug wires, fuel lines and any battery or servo wires are correctly installed and well-secured.
8. Once you are happy with the fit of your cowling, proceed to installing the cowl. Use a 2.5mm hex driver, (4) M3 x 20 socket head cap screws and (4) M4 flat washers to secure it in place. All four screws are installed from the inside of the fuselage. Two screws are located near the top, outside edges of the cowling. The other two are located slightly below the middle, outside edges of the cowling.



- 9. Install your propeller and spinner. For the DA-70, we recommend a Falcon 25x8W carbon fiber propeller and a Falcon 5-inch (127mm) carbon fiber spinner.

ELECTRIC POWER SETUP

The RV-8 70cc FLS was designed for electric power as well.

Flight time with the recommended equipment is around 5 to 6 minutes with proper throttle management, leaving you with good reserve. Slow flight and touch and goes can be up to 10 minutes long.

For your first flights on the recommended setup, set your timer for 4 minutes and check the remaining capacity when charging your batteries. Adjust the timer according to your particular flight style

Recommended Electric Power System:

- Potenza 65cc 185kV Motor (FPZM65CC)
- (4) 2.5 in (63mm) motor standoffs
- Potenza 6S 6200mAh 40C batteries (two in series for 12S)
- Castle Edge 160HV ESC
- Mejzlik 25 x 12S Propeller

MOTOR INSTALLATION

Required for this section

Components

- Fuselage Assembly
- Motor
- M5x15 Socket Head Cap Screw (4)
- M5 Flat Washer (4)
- 1/4x3/4 Socket Head Cap screw (4)
- 1/4 Flat Washer (4)
- 2.5in (63mm) Standoff (4)
- M5x15 Socket Head Cap Screw (4)
- M5 Flat Washer (4)

Tools

- 2mm Hex Driver
- #1 Phillips Screwdriver

Adhesives/Building Materials

- Blue Thread Lock
- 5min Epoxy
- Mixing Cups
- Mixing Sticks



- 1. The 63mm motor standoffs used are threaded for ¼ -20 bolts on the firewall side and 5mm bolts on the motor side.
- 2. Using 5-minute Epoxy, glue the (4) 3mm plywood washers to the firewall. This will provide the correct clearance between the spinner and cowling.

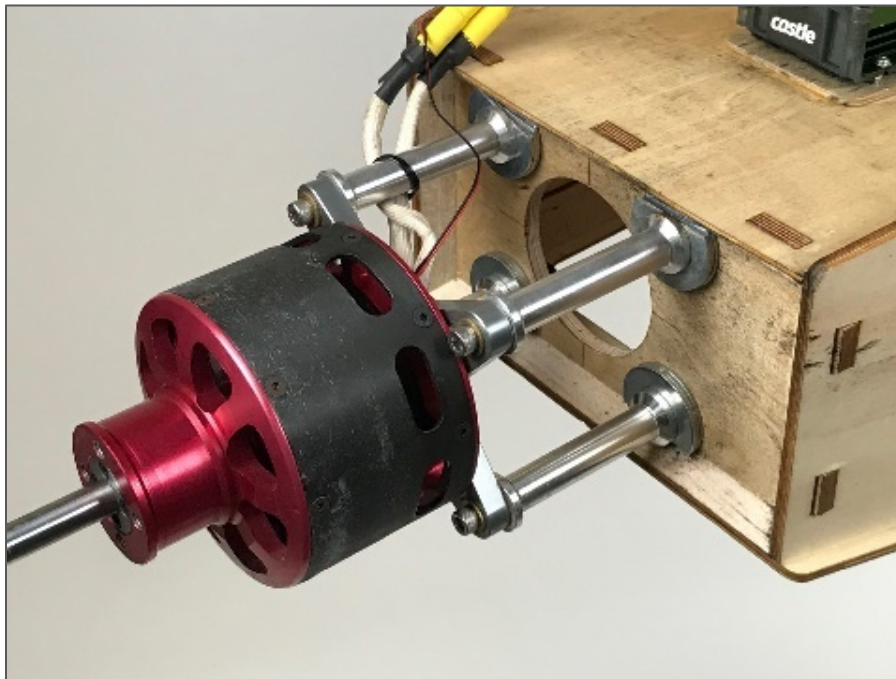

- 3. Use (4) 1/4 x 3/4-inch socket head cap screws and (4) 1/4-inch washers to mount the motor. Be sure to apply blue thread lock when securing them.
- 4. Install the motor using (4) M5 x 10 socket head cap screws with (4) M5 washers. Be sure to use blue thread lock when securing them.

ESC INSTALLATION

Required for this section

Components

- Fuselage Assembly
- ESC
- M2x12 Phillips Head Self-Tapping Screws (4)

Tools

- #1 Phillips Screwdriver
- Drill
- 1.5mm Drill Bit

Adhesives/Building Materials

- Thin CA



1. Mount the ESC on the bottom of the motor box as shown in the picture above. This is a great location for cooling. Mark the mounting hole locations and use a 1.5mm drill bit to drill holes in the mounting locations on the motor box. Using a #1 Phillips Screwdriver, thread an M2 x 12 Phillips-head self-tapping screw into each of the holes. Remove the screw. Use thin CA to harden the threads, and once the CA has fully cured, you can install your ESC.
2. Tidy up and secure all the wiring.

BATTERY TRAY INSTALLATION

Required for this section

Components

- Fuselage Assembly
- Electric Battery Tray
- Sticky Velcro
- Flex Innovations Battery Hook and Loop Strap Medium 30mm Long (4). FPMA1016

Tools

Adhesives/Building Materials

- 30 Minute Epoxy
- Mixing Cups
- Mixing Sticks



1. Using 30-minute epoxy, glue the battery tray on top of the front battery location. This piece is required to strengthen the area for the increased weight of the electric flight batteries. Let the epoxy cure before proceeding with the next step.



2. After the epoxy cures install adhesive-backed hook and loop tape as shown in the above picture. Adjust battery the slots as needed.



Quique's Tip:

- For proper CG on our prototype, the motor batteries are mounted in the location shown in the image above. The receiver batteries are located at the rear edge of the receiver tray, and the rudder servo is mounted in the tail of the fuselage.
- If adjustments are needed for proper CG, you can move one motor battery to the fuel tank mounting tray, or also move the rudder servo forward to the pull-pull location under the canopy. NOTE: In its stock form, the fuel tank tray cannot support heavy batteries and high stress loads. If you need to mount batteries here to achieve CG, you should use some 1/8-inch ply and laminate it over the existing tray for added rigidity.

3. Install four 300mm (11-3/4 inch) Flex Innovations Hook and Loop straps through the slots in the battery tray to secure the electric flight batteries.

MOTOR/ESC COOLING



1. When using the electric power setup, we recommend that you do not use the provided baffles for gas engines. The front openings provide enough cooling for the electric motor and ESC.

For cooling air exhaust, open the rear lip on the bottom of the cowling and the hole in the bottom of the fuselage just behind the landing gear mount.

FINAL ASSEMBLY

RADIO INSTALLATION

Required for this section

Components

- Fuselage Assembly
- Receiver
- Receiver Switch
- Aura Professional (Optional)
- Receiver Batteries
- Hook and Loop Straps
- Adhesive-Backed Hook and Loop Tape
- Tie-Wraps

Tools

- Hobby Knife with #11 Blade
- 2mm Hex Driver
- #1 Phillips Screwdriver

Adhesives/Building Materials

- Thin CA

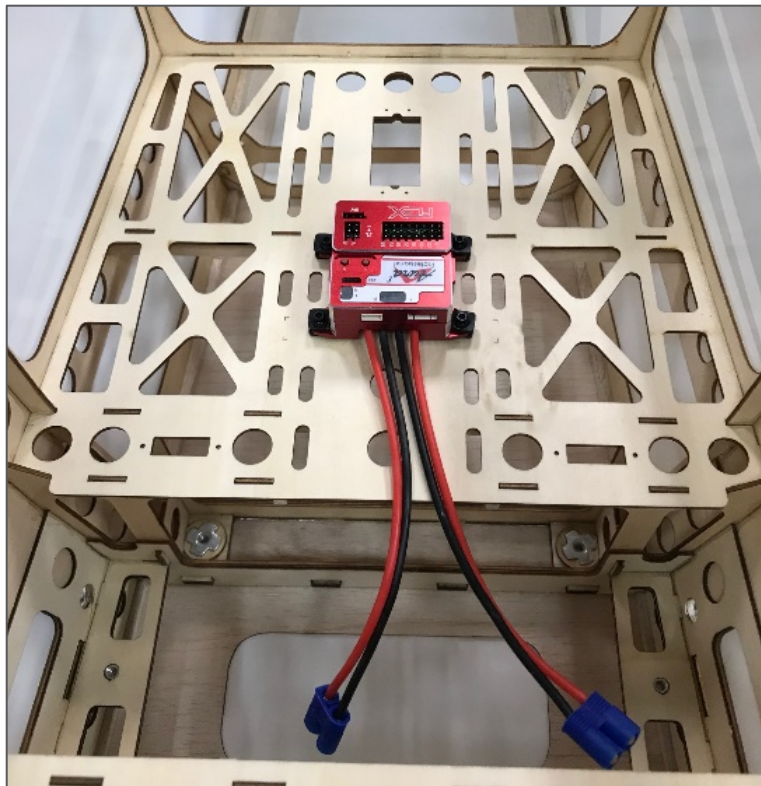

- 1A. If you are using an Aura Professional, it can be mounted forward of the rudder servo location as shown in the picture above. There are pre-cut holes to start the mounting screws easily. **DO NOT** use hook and loop tape to mount the Aura.

Use a #1 Phillips screwdriver to thread an Aura mounting screw into each of the pre-cut holes in the mounting tray. Remove the screw and apply a small amount of thin CA to

each of the holes to harden the threads cut by the screw. Let the CA fully cure before mounting the Aura and securing the (4) screws.

- 1B. If not using the Aura, choose a mounting location for your receiver. It can be mounted in the same location as the Aura in the image above if desired. Keep your CG in mind as well when choosing a mounting location. We recommend using hook and loop tape on the back of the receiver, as well as a hook and loop strap to secure it in place.

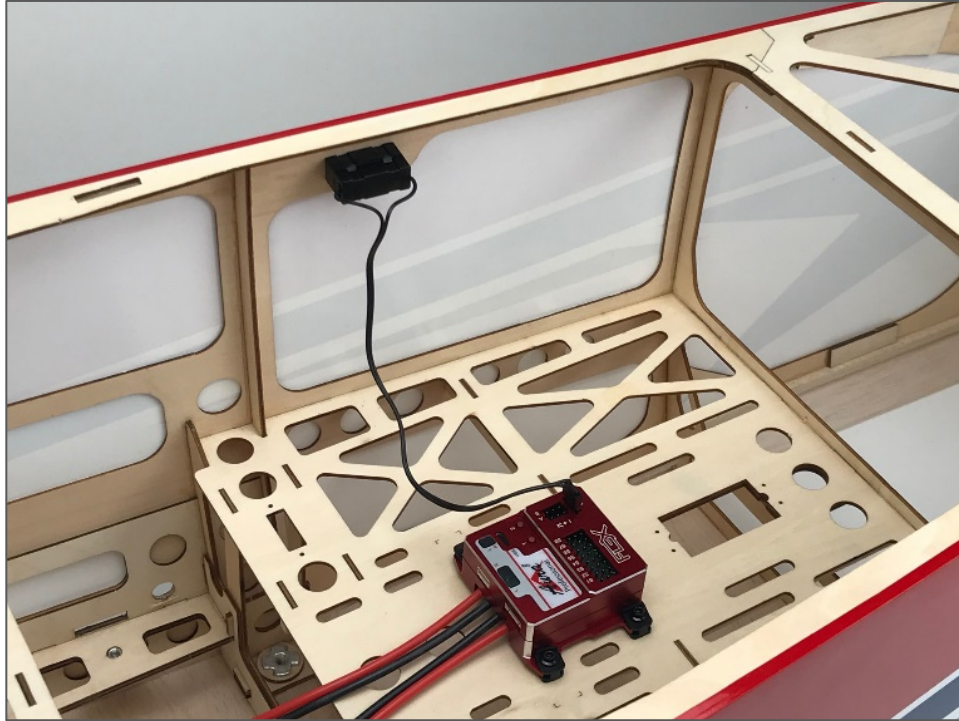

2. Locate the receiver switch location just under the canopy, and just in line with the Aura & receiver area as indicated in the picture above. Note that there are switch locations on both sides of the fuselage to suit your preference. Remove the covering from the hole of your choice using a hobby knife with a #11 blade. Mount your switch, being sure to orient the on/off plate properly. If your switch mounting screws thread into metal fittings or nuts, be sure to use blue thread lock. If your switch mounting screws thread into plastic, DO NOT use thread lock as it may damage the plastic.

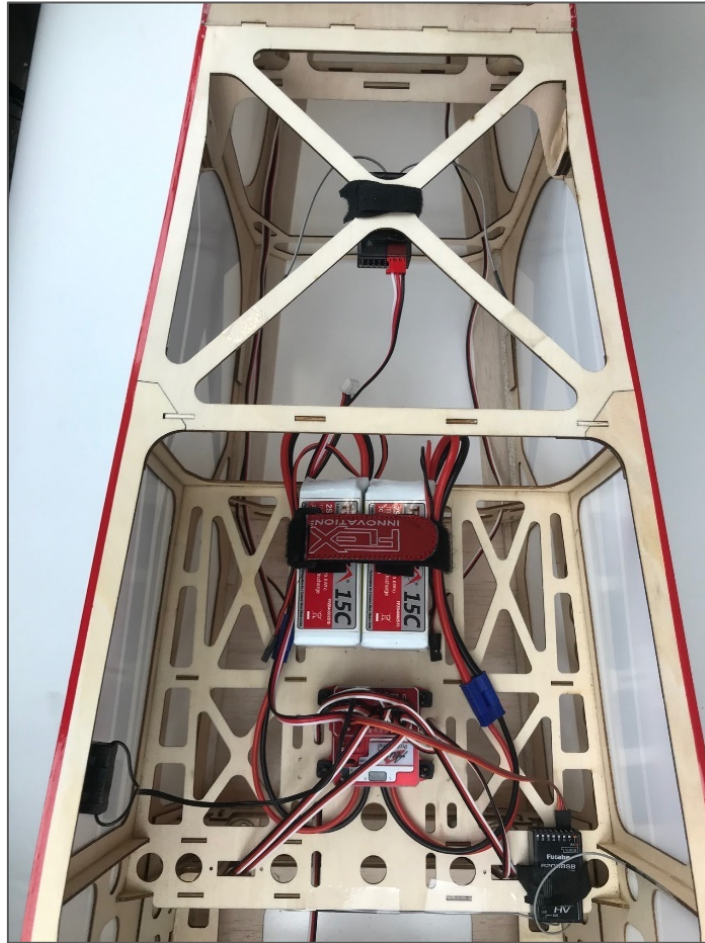

3. Make all necessary servo connections to your receiver and/or Aura. Install the two recommended receiver batteries as needed to achieve the proper CG. This picture uses the rudder servo in the tail with a push/pull setup and the DA-70 engine.

In the image above, we are using the Aura 8 Pro with dual Futaba S.Bus receivers. One is mounted in the tray and the other behind and above for maximum signal strength. Reference your receiver's instruction manual for mounting details.

WING INSTALLATION

Required for this section

Components

- Fuselage Assembly
- Right and Left Wing Panels
- Carbon Fiber Wing Tube
- M4x15 Socket Head Cap Screw (4)
- M4 Flat Washer (4)

Tools

- 3mm Hex Driver
- Hobby Knife with #11 Blade
- Covering Iron or Trim Iron

Adhesives/Building Materials



1. Use a hobby knife with a sharp #11 blade to remove covering from these holes. Be sure to leave 1/8-inch (3mm) overlap inside the hole and use a covering or trim iron to seal the covering into the fuselage.
2. Insert the carbon fiber wing tube into the fuselage ensuring that it is roughly centered.



3. Slide one wing panel onto the wing tube. Feed the aileron and flap servo leads through the fuselage opening. Continue pushing the wing onto the tube until it is fully seated against the side of the fuselage. Ensure the servo wires are routed properly into the fuselage. Make sure the wing tube doesn't slide out the other side of the fuselage, and that the fiberglass wing tabs align with the slots in the wing before fully seating the wing against the fuselage.

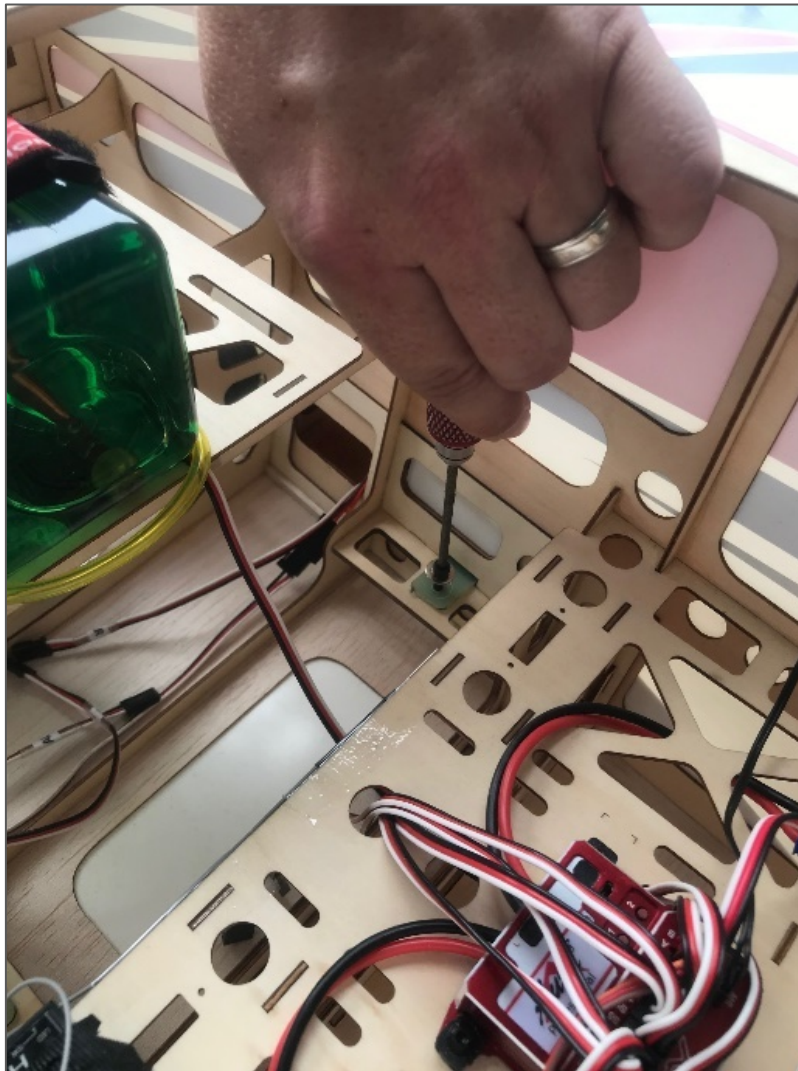

- 4. Secure each wing panel with two M4x15 socket head cap screws and two M4 flat washers using an M3 hex driver. Repeat the process for the other wing panel.
- 5. Connect the aileron and flap leads to their corresponding extensions connected to the Aura, or to your receiver if Aura is not used.

Quique's Tip:

Using medium CA, glue the (4) M4 flat washers to the (4) M4 x 15 socket head cap screws. This will assist in the assembly of the model.



PILOT INSTALLATION (OPTIONAL)

Required for this section

Components

- Pilot
- Canopy

Tools

- Hobby Knife with #11 Blade

Adhesives/Building Materials

- Medium CA



1. The foam cockpit floor has a dotted line denoting the cutout area. Take a #11 blade and cut three of the four side of the rectangle as shown in the picture above. This will allow you access for mounting the pilot. Once you mount the pilot, glue the foam back in place using medium CA.



2. The canopy hatch already has a cross-member for the pilot installed. In the image above, the two slots are for two M3 screws and M3 washers to secure the pilot in place. They do not have to be used.



3. In the full-size RV-8, the pilot sits in the front seat when flying solo. Your installed pilot should appear like the image above.

CANOPY INSTALLATION

Required for this section

Components

- Fuselage Assembly
- Canopy
- M3x20 Socket Head Cap Screw (2)
- M4 Flat Washer (2)

Tools

- 2.5mm Hex Driver

Adhesives/Building Materials

1. As noted at the beginning of this manual, the canopy has hooks along the sides to help secure the canopy in place without the use of additional screws. Place the canopy flat, and slightly aft of its final location, noting to align these hooks with the slots in the fuselage. Gently push the canopy forward until it reaches the cowling and sits appropriately in place.

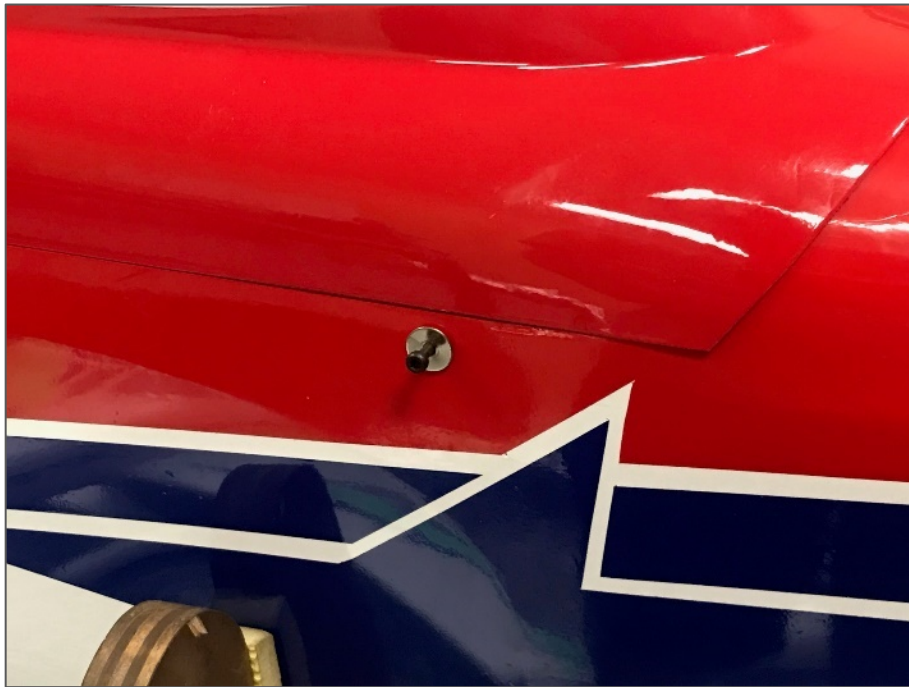

- 2. Using your 2.5mm hex driver, secure the canopy with two M3x20 socket head cap screws and two M3 flat washers through the holes in the fuselage towards the rear of the canopy, one on each side.

DECAL INSTALLATION

A traditional set of clear decals is provided with the RV-8 70cc.

However, if you want the very best finished appearance, we recommend the Premium Vinyl Graphics Kit made by Callie Graphics and sold by Flex Innovations. The part numbers are listed below.

FPM2022 RV-8 70cc Premium Vinyl Graphics Kit - Red

FPM2023 RV-8 70cc Premium Vinyl Graphics Kit - Camouflage

Use the drawings provided below for a guide to apply decals to your model.

- 1. Thoroughly clean the model to ensure it is free of oil, fingerprints, and dust.
- 2. Separate the decals, but do not remove the paper backing.
- 3. Prepare a dishpan or small bucket with a mixture of warm water and liquid dish detergent. The ratio should be approximately one teaspoon per gallon of water.
- 4. Submerge the decal into the water/soap mixture and gently remove the paper backing. Removing the backing under water prevents fingerprints from being visible on the back side of the decal
- 5. Apply some water/soap mixture with your palm to the area desired. Once the area is saturated, position the sticker on the airplane. Even though these are not water transfer

decals, using wet application methods allows the sticker to be repositioned, reduces bubbles, and eliminates fingerprints and other blemishes from being visible.

- 6. Hold the decal in place and use a paper towel to gently wipe most of the water away.
- 7. Use a soft piece of balsa or similar to squeegee out the remaining liquid from underneath the decal.
- 8. Repeat the process until all decals are applied. Do not move, or otherwise touch the model for at least 24 hours to allow adequate time for the remaining water to evaporate.



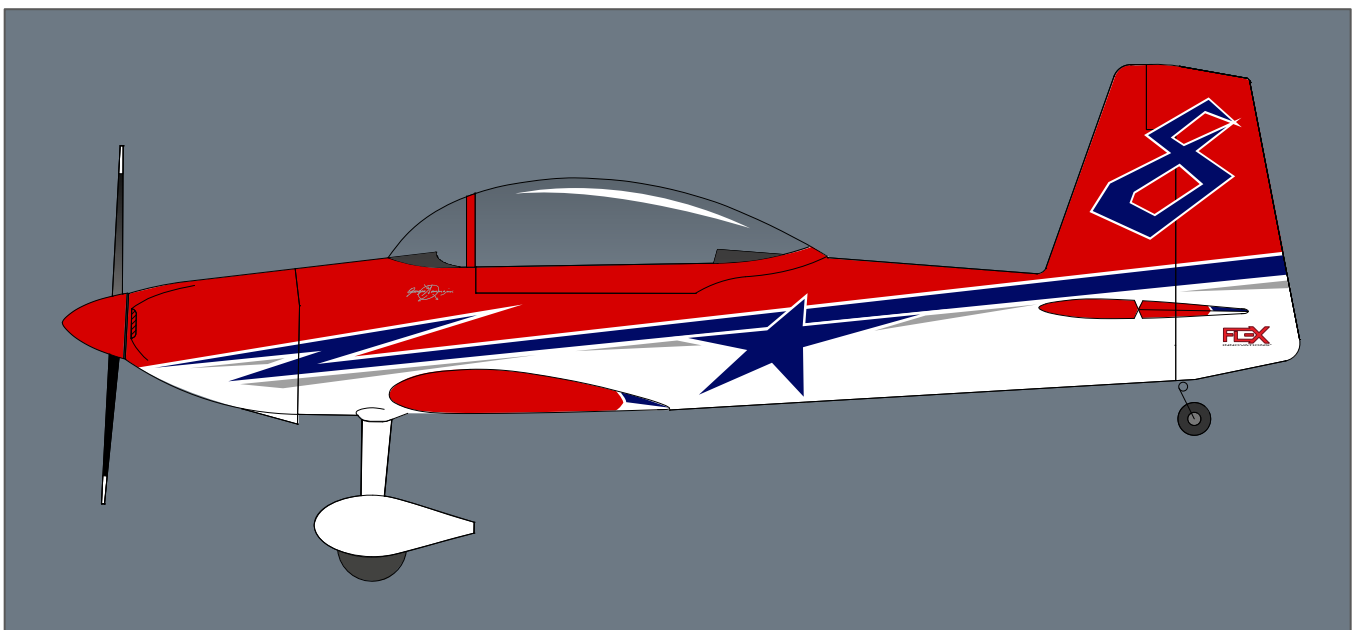
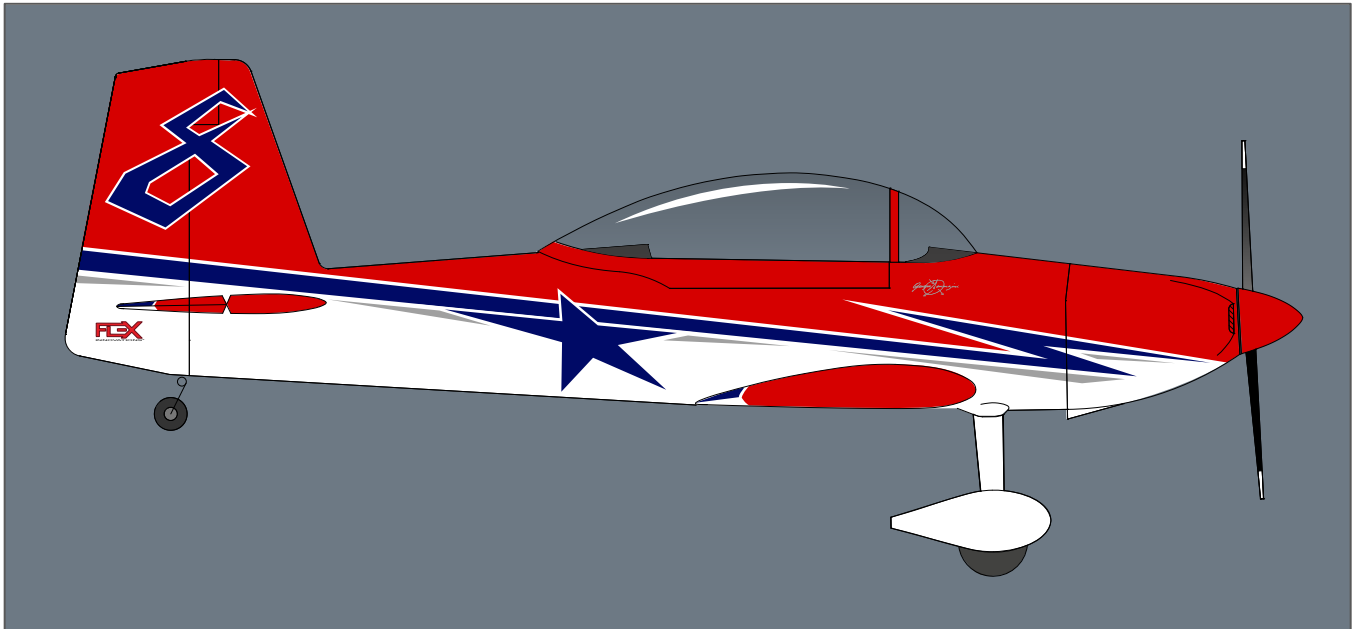

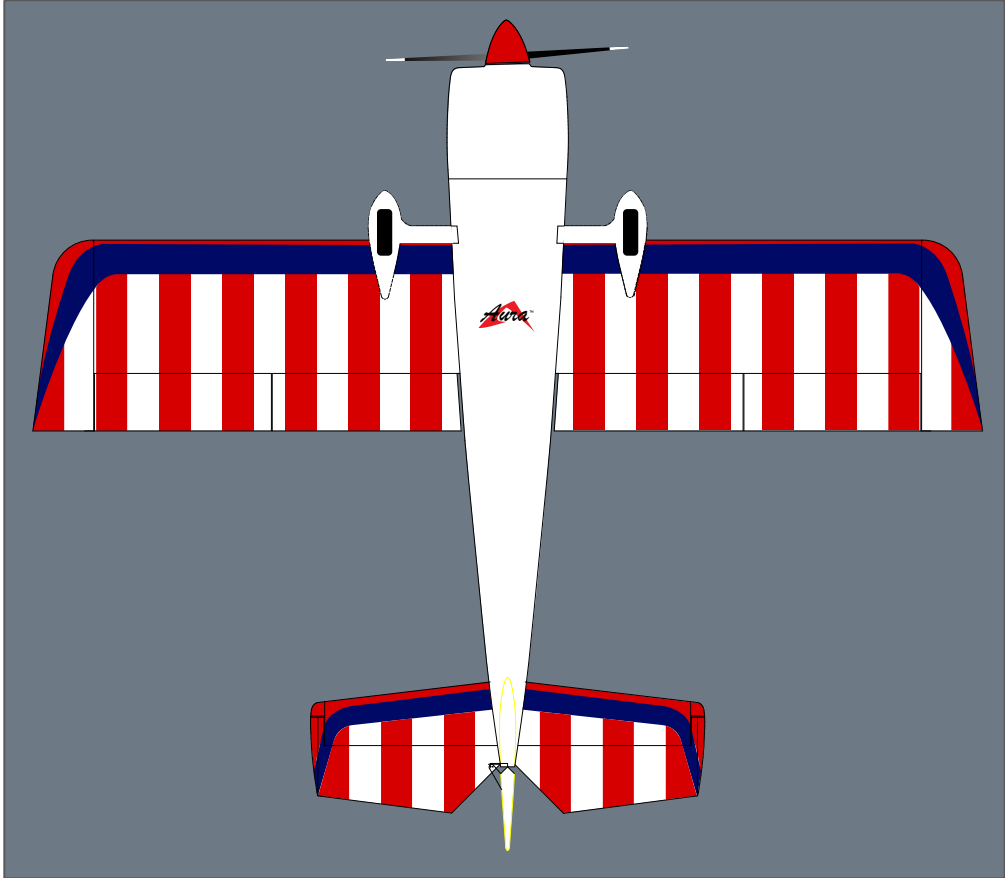
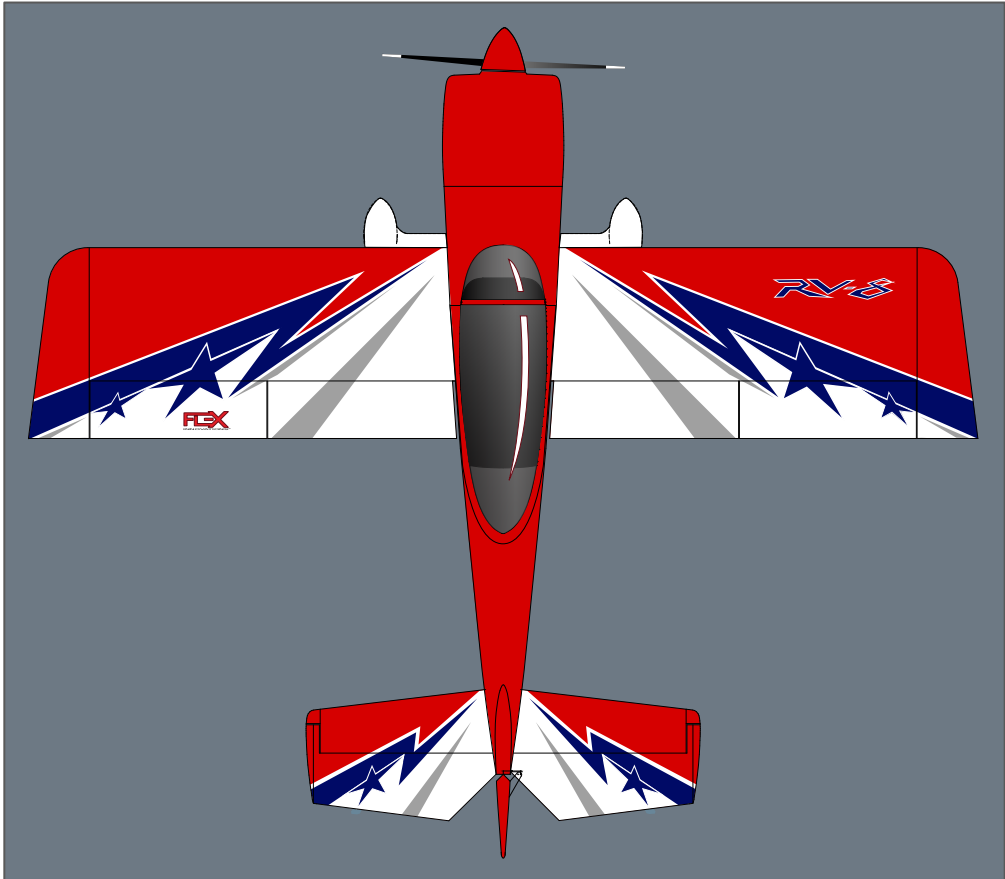
RV-7 70cc FLS – Red Scheme

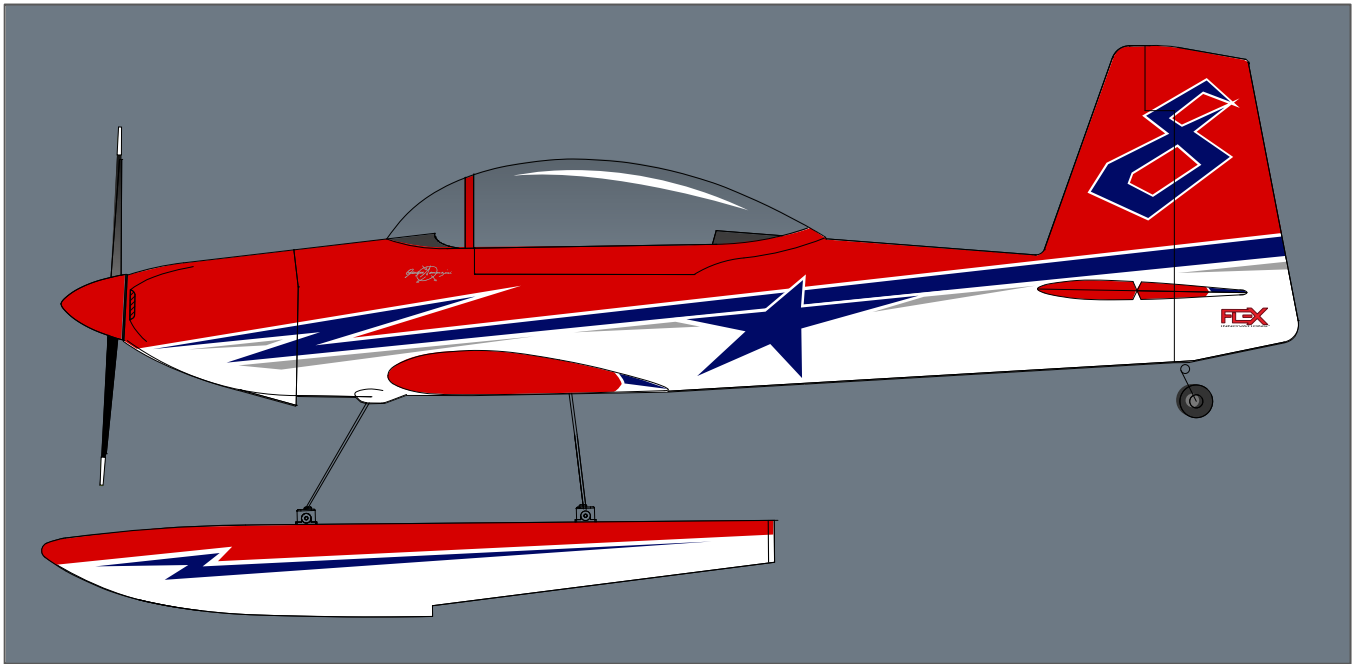





ULTRACOTE COLORS



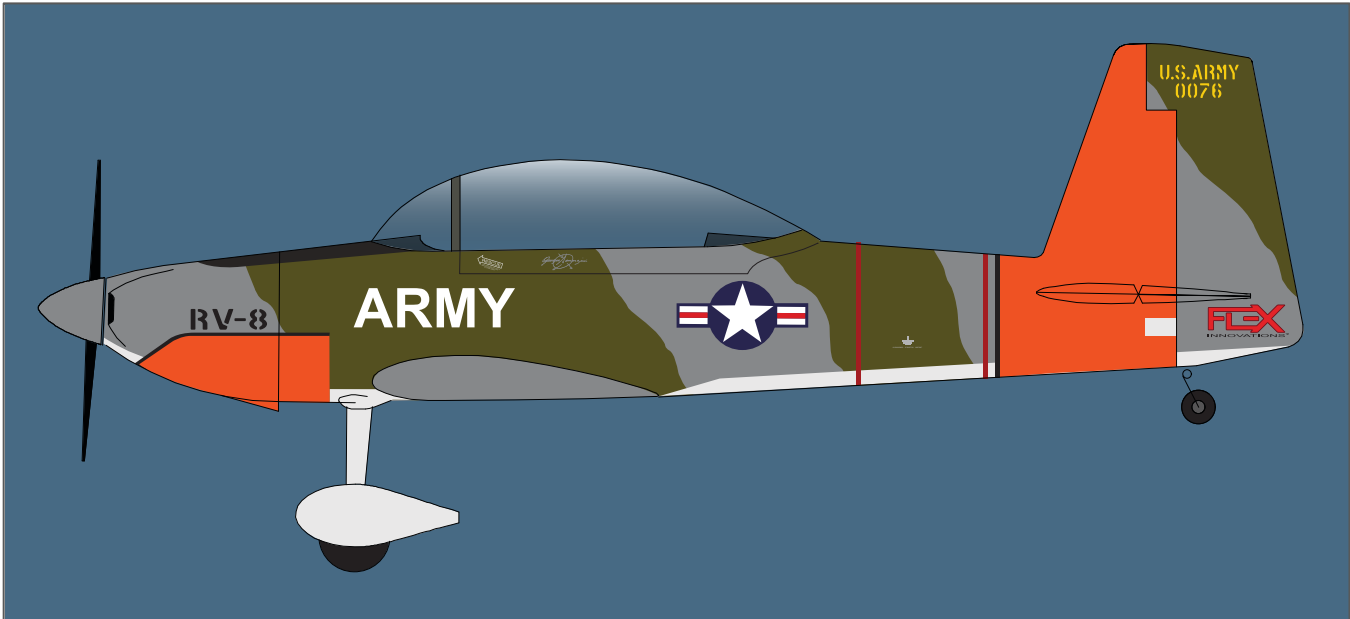
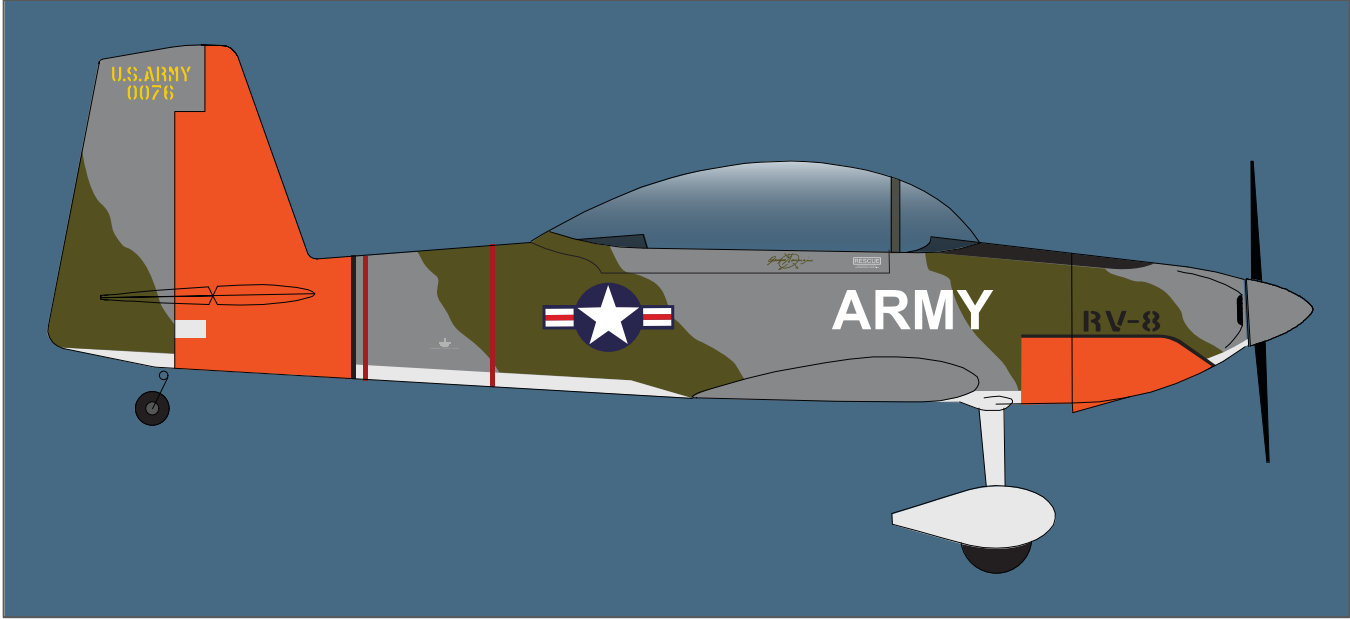

-  TRUE RED (HANU866)
-  MIDNIGHT BLUE (HANU885)
-  SILVER (HANU881)
-  WHITE (HANU870)

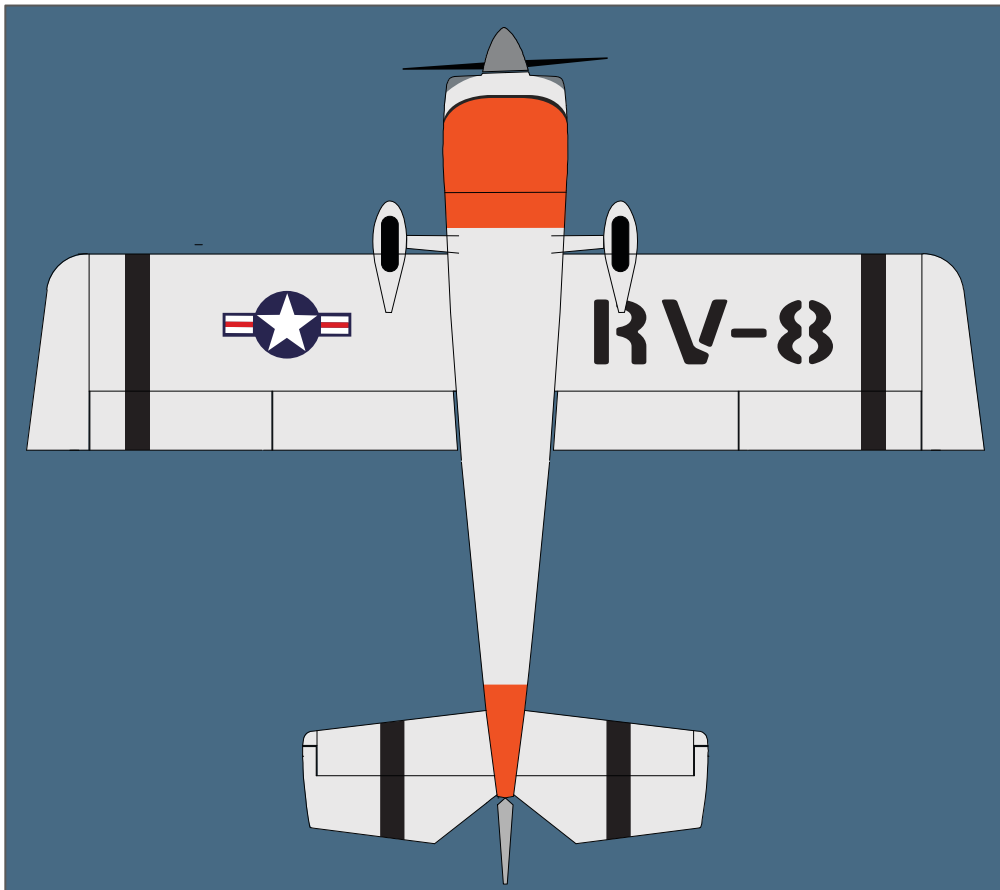
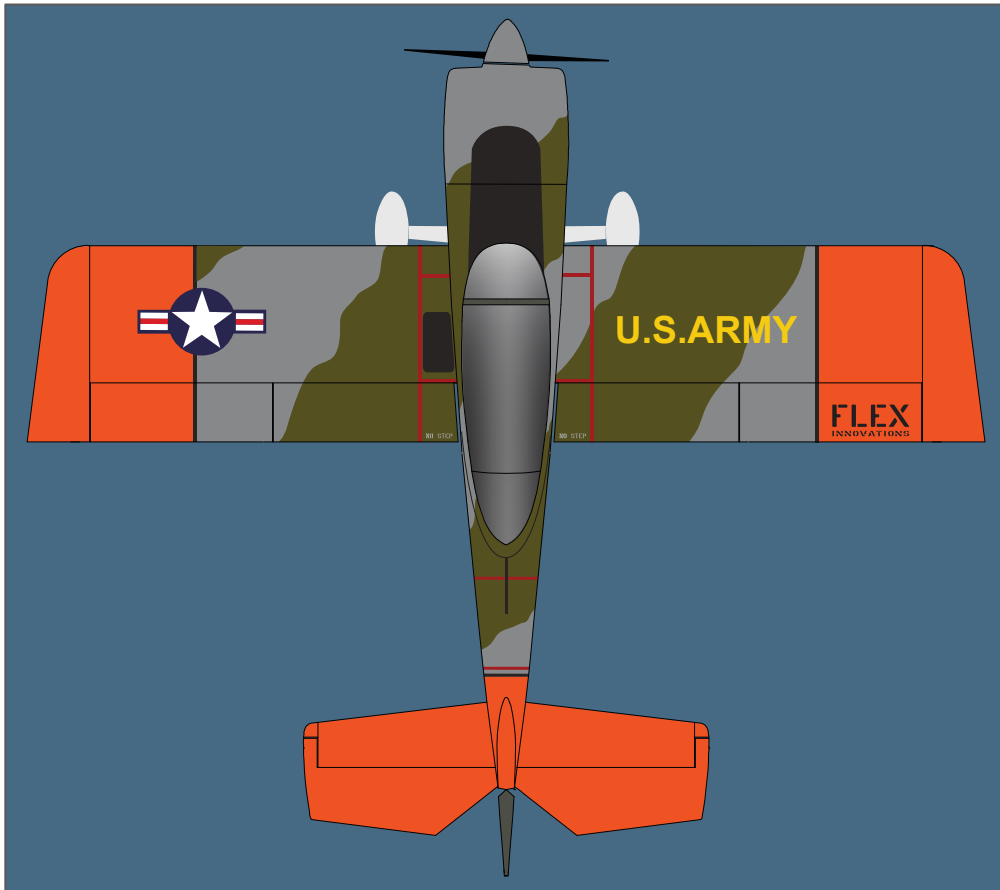
RV-8 70cc FLS – Camouflage Scheme

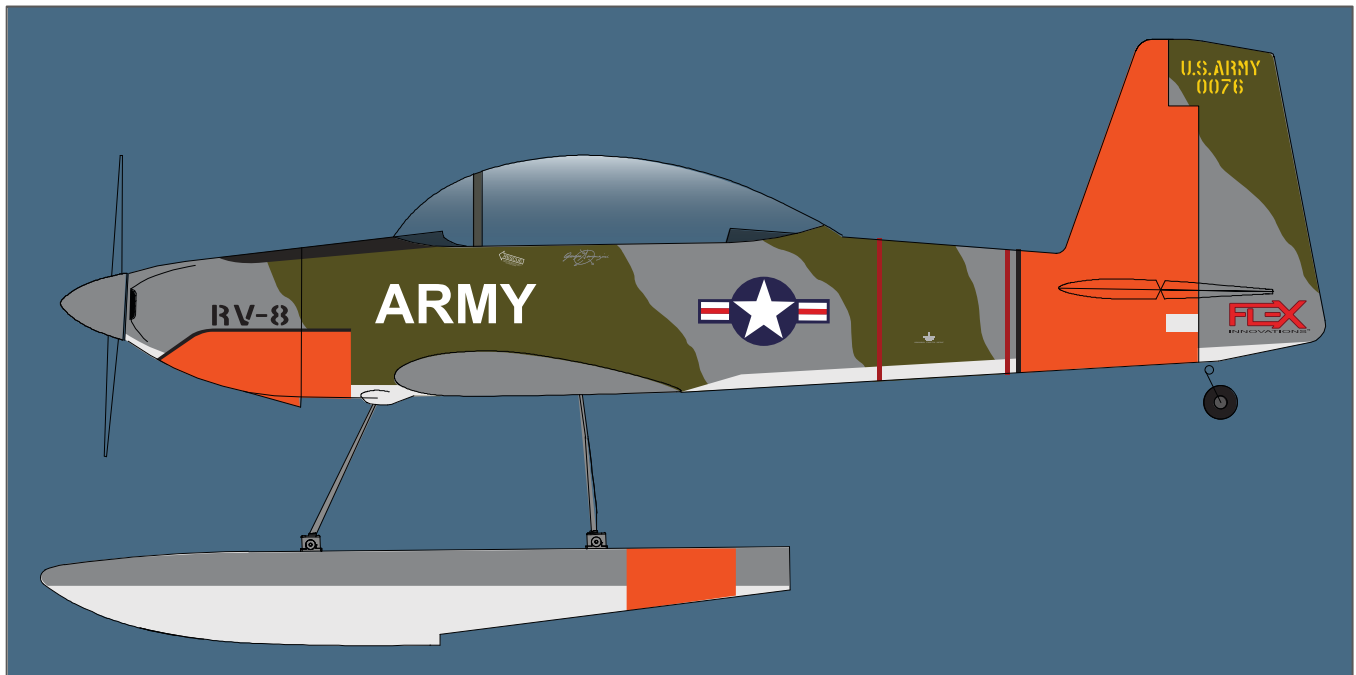





ULTRACOTE COLORS	
	OLIVE DRAB (HANU904)
	LIGHT GRAY (HANU882)
	ORANGE (HANU877)
	WHITE (HANU870)
	BLACK (HANU874)

FINAL SETUP AND FLYING NOTES

CENTER OF GRAVITY

Setting the center of gravity is one of the most important steps for success, particularly with a new airplane. The Flex Innovations RV-8 70cc FLS is an airplane with a wide performance envelope and large control surface throws. These two factors combine to make the RV-8 70cc FLS a very enjoyable aircraft to fly, but if the center of gravity is not within an acceptable range, it will make the airplane difficult to control. To have the most success and enjoyment from your RV-8 70cc FLS, please follow the next steps very carefully.

Before balancing your model, please ensure that all of the components are installed in your airplane. This means the batteries, servos, linkages, hardware, propeller, and spinner. In other words, the aircraft should be completely assembled as if you were getting ready to fly it. The airplane must be in ready-to-fly condition (without fuel), otherwise the measurement will not be accurate.

There are several methods for determining the correct center of gravity; from using a CG machine, to using fingers and a friend. Regardless of the method used, ensure that the tests are accurate and repeatable. If there are any inconsistencies between measurements, work to isolate the source of the error(s) to ensure that the test can be repeated with the same results. If lifting the model by the wing tips, lift at the outside-most wing rib location and not the wing tip itself or damage to the model may result.

During testing, it was found that the acceptable CG range on the RV-8 70cc FLS is 170 to 190mm (6-11/16 to 7-1/2 inches) AFT from the LEADING EDGE of the wing. Depending on your flying style and preference, you should choose a specific CG within this range.

Quique's Preferred CG:

Through Quique's extensive testing, Quique has found that he prefers the CG located at 182mm (7-5/32 inches) AFT from the LEADING EDGE of the wing.

Quique's Tip:

The CG can be easily achieved using the recommended equipment and placements recommended in this manual. However, some variance of weight between models is possible. For this reason, it is recommended to leave the batteries uninstalled and install them in the location necessary to achieve the recommended CG. There are three battery mounting locations in the aircraft for this purpose. The forward location is just in front of the fuel tank. A middle position is provided next to the fuel

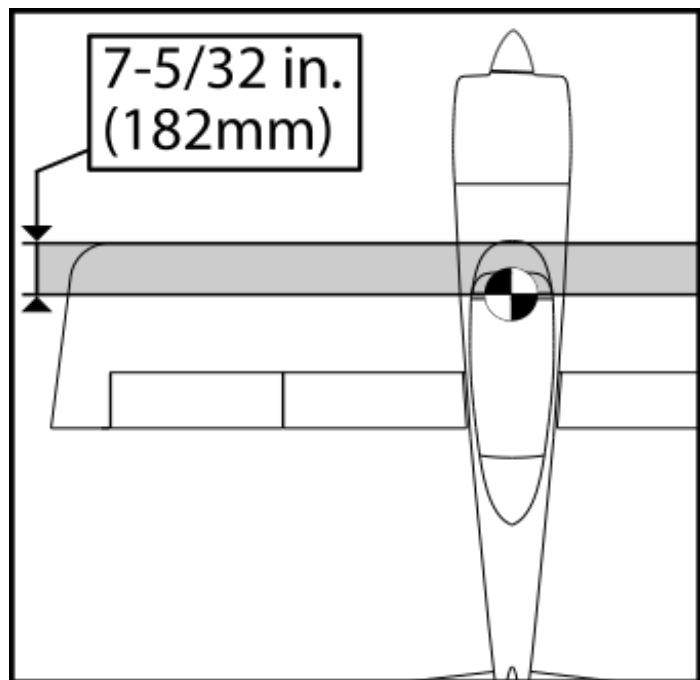

tank, and the aft position is on the rudder servo and receiver tray, near the back of the canopy. Choose a location that suits your needs for your specific setup.

AURA 8 PROFESSIONAL

If you choose to use Aura 8 Professional AFCS, you can find the information on the RV-8 70cc FLS Aura set-up in the Aura Config Tool and in the wiki at:

http://wiki.flexinnovations.com/wiki/RV8_70cc

STARTING CONTROL SURFACE THROWS AND EXPONENTIAL

The following throws and exponential have been tested thoroughly during the development of the airplane and have been determined to be the optimal starting point for the RV-8 70cc FLS. As you become more familiar with the airplane, you may tweak the rates and expos to better suit your flying style, but these numbers provide a very good starting point.

NOTE: Aileron throws are measured at the trailing edge and tip of the aileron. Flaps are measured at the trailing edge of the flap at the aileron. Elevator and rudder throws are measured from the center of the fin or stab to the center of the counterbalance. Since expo directions vary by transmitter manufacturer, all expos listed below are those that make the control feel softer around the stick's center position.

RV-8 70cc Control Throws and Expo

	Low Rate (Flaps Do Not Move w/Aileron in Low Rate)		High Rate (Flaps Move & Match Ail in High Rate)	
	Up	Down	Up	Down
Aileron	130mm (5-1/8 in.)	115mm (4-1/2 in.)	130mm (5-1/8 in.)	115mm (4-1/2 in.)
Elevator	15mm (19/32 in.)	15mm (19/32 in.)	70mm (2-3/4 in.)	70mm (2-3/4 in.)
Rudder	33mm (1-9/32 in.)	33mm (1-9/32 in.)	47mm (1-27/32 in.)	47mm (1-27/32 in.)
Aileron > Flap Mix	0mm (0 in.)	0mm (0 in.)	Even with Aileron	Even with Aileron
Aileron Expo	25%	25%	40%	40%
Elevator Expo	25%	25%	40%	40%
Rudder Expo	10%	10%	20%	20%

	Half Flap	Full Flap
Flap Travel (From Flap Switch)	60mm (2-3/8 in.)	100mm (3-15/16 in.)
Flap > Elevator Mix (Down Elevator)	12%	18%

High rate should be reserved for advanced aerobatics and low rate should be reserved for sport flying and general aerobatics. It is highly recommended that for your first flights, take offs and landings be done in low rate.

RANGE TESTING

Carefully follow the binding and range testing instructions included with your radio equipment. If there are any issues passing the test range, please consult your transmitter and receiver manuals or contact your transmitter and receiver manufacturer to determine the appropriate solution before attempting to fly.

BEFORE FIRST FLIGHT

Before going to the field for your first flight, please go over the finished, fully assembled model at home. The key to a successful first flight is preparation and ensuring that your plane is airworthy.

1. For optimal performance of your model, balance your propeller and spinner. Most propellers are balanced fairly-well out of the package, however, some fine-tuning can make a mediocre propeller perform great. An out-of-balance propeller or spinner can wreak havoc on the electronic components in the airplane, as well as prematurely shorten the life span of the engine, servos or even the model itself. A balanced propeller will be quieter, generate more thrust, produce less vibration, and operate more efficiently than one that is not balanced.
2. Re-check all linkages and connections, including those that may have been assembled by the factory. Ensure pushrods are sufficiently threaded into ball links, ensure that all metal-to-metal connections have thread lock applied and ensure that all controls move freely and in their proper direction.
3. Verify proper functioning, break-in, and operation of your engine choice. Ensure that the fuel-air mixture is correct, and that the engine is producing full power. If you are not familiar with gas engines, ask for the assistance of a more experienced pilot in your area or speak with your engine manufacturer.
4. Secure any loose wiring inside the fuselage or wings and be sure that they are secured in a way that they do not rub or chafe.
5. Ensure that all batteries (transmitter, receiver, ignition or flight packs) are fully charged prior to leaving for the flying field.
6. Take a few moments to assemble the airplane away from commotion, talkative onlookers, or any other distractions. Ensure that all connections are properly made and secured, the wing bolts are tight and take a few minutes to plan out your first flight.
7. If your engine is new, avoid prolonged full throttle runs and vertical climbs. Limit the first few flights to a short flight time. Start off short, gradually lengthening the flight times as you become comfortable with the performance of your engine. Six minutes is a good time to limit your first flights to. As you become more familiar with the airplane and begin to fly it in a more aggressive manner, monitor the temperature of the engine and adjust the fuel-air mixture according to your engine manufacturer's recommendations.

AMA SAFETY CODE

When flying your aircraft, we recommend following the guidelines set by the Academy of Model Aeronautics (AMA). You can find their Safety handbook as well as more information on the AMA at their website, located at the address below.

<https://www.modelaircraft.org/>

REPLACEMENT PARTS

FPM2000A	RV-8 70cc FLS, Red
FPM2000B	RV-8 70cc FLS, Camouflage
FPM2050A	RV-8 70cc FLS ARFSV, Red
FPM2050B	RV-8 70cc FLS ARFSV, Camouflage
FPM2001A	RV-8 70cc FLS Fuselage w/o hatches, Red
FPM2001B	RV-8 70cc FLS Fuselage w/o hatches, Camouflage
FPM2002AL	RV-8 70cc FLS Left Wing Panel, Red
FPM2002AR	RV-8 70cc FLS Right Wing Panel, Red
FPM2002BL	RV-8 70cc FLS Left Wing Panel, Camouflage
FPM2002BR	RV-8 70cc FLS Right Wing Panel, Camouflage
FPM2003A	RV-8 70cc FLS Horizontal Stabilizer with Elevators, Red
FPM2003B	RV-8 70cc FLS Horizontal Stabilizer with Elevators, Camouflage
FPM2004A	RV-8 70cc FLS Vertical Stabilizer with Rudder, Red
FPM2004B	RV-8 70cc FLS Vertical Stabilizer with Rudder, Camouflage
FPM2005A	RV-8 70cc FLS Cowling with hardware, Red
FPM2005B	RV-8 70cc FLS Cowling with hardware, Camouflage
FPM2006A	RV-8 70cc FLS Canopy Hatch with cockpit, Red
FPM2006B	RV-8 70cc FLS Canopy Hatch with cockpit, Camouflage
FPM2007	RV-8 70cc FLS Painted Carbon Fiber Landing Gear
FPM2008	RV-8 70cc FLS Wheel Pants with hardware
FPM2009	RV-8 70cc FLS Carbon Wing & Stab Tubes
FPM2010	RV-8 70cc FLS Tail gear with wheel and Hardware
FPM2011	RV-8 70cc FLS Main Wheel and Axle Set (5 in. diameter)
FPM2013	RV-8 70cc FLS Hardware Set
FPM2017	RV-8 70cc FLS Laser Cut Wood Parts
FPM2019	RV-8 70cc FLS Lightweight 24oz Fuel/Smoke Tank
FPM2021	RV-8 70cc FLS Vertical Fin Carbon Fiber Tube

OPTIONAL ACCESSORIES

FPM2022	RV-8 70cc FLS Premium Vinyl Graphics Set, Red
FPM2023	RV-8 70cc FLS Premium Vinyl Graphics Set, Camouflage
FPM2016A	RV-8 70cc Float Set, Red
FPM2016B	RV-8 70cc Float Set, Camouflage
FPM2014	Premium Wing and Tail Bag Set, RV-8 70cc FLS
FPM1624	20mm Aluminum Engine Stand Offs
FPMDA70	Desert Aircraft DA-70 engine
FPMDA70MUFLR	Desert Aircraft DA-70 Muffler Set
FPMFAL5CGS	Falcon Carbon Fiber Spinner, 5 inch
FPMHOLYG2	Holy Smokes Gen2 Smoke System
FPMPF249CF	Flex 24x9 Two Blade Carbon Fiber Propeller
FPMPF258WCF	Falcon 25x8W Two Blade Carbon Fiber Propeller
FPZA1036	Aluminum Servo Arm 2-inch Clamping (25T).
FPZA1037	Aluminum Servo Arm 4-inch Clamping (25T).
FPZA1040	Servo Connector Safety Clip Set (10)
FPZAURA08PRO	Aura 8 Professional AFCS
FPZBR20002S15	2S 2000mAh 15C Li-Po Receiver Battery
FPZBR40002S15	2S 4000mAh 15C Li-Po Receiver Battery
FPZDS22209HV	Potenza DS22209 High Voltage, Titanium Gear Servo
FPZDS49010BLHV	Potenza DS49010 Brushless, High Voltage Servo
ISDTD2	iSDT D2 Smart AC Dual Battery Charger 100W x 2

LIMITED WARRANTY

Warranty Coverage

Flex Innovations LLC and its authorized resellers (“Flex”) warrant to the original purchaser that this product (the “Product”) will be free from defects in materials and workmanship at the date of purchase.

Outside of Coverage

The warranty is not transferable and does not cover:

- (a) Products with more than 45 days after the purchase date
- (b) Damage due to acts of God, accident, misuse, abuse, negligence, commercial use, or due to improper use, installation, operation, or maintenance
- (c) Damage to other components or assemblies associated with the use of the Product.
- (d) Modification of or to any part of the Product
- (e) Product not purchased from an authorized Flex Innovations dealer or distributor.
- (f) Product that has been partially, or fully assembled
- (g) Shipping damage
- (h) Cosmetic damage
- (i) Services or labor associated with the repair, use or assembly of the Product.

OTHER THAN THE EXPRESS WARRANTY ABOVE, FLEX MAKES NO OTHER WARRANTY REPRESENTATION, AND HEREBY DISCLAIMS ALL IMPLIED WARRANTIES, INCLUDING, WITHOUT LIMITATION, THE IMPLIED WARRANTIES OF NONINFRINGEMENT, MERCHANTABILITY AND FITNESS FOR A PARTICULAR PURPOSE. THE PURCHASER ACKNOWLEDGES THAT THEY ALONE HAVE DETERMINED THAT THE PRODUCT WILL SUITABLY MEET THE REQUIREMENTS OF THE PURCHASER’S INTENDED USE.

Purchaser’s Remedy

Flex’s sole obligation and purchaser’s sole and exclusive remedy shall be that Flex will, at its option, either (i) service, (ii) replace any part of the Product determined by Flex to be defective, or (iii) replace the Product determined by Flex to be defective. Flex reserves the right to inspect all Product(s) involved in a warranty claim. Service or replacement decisions are at the sole discretion of Flex. Proof of purchase is required for all warranty claims. **SERVICE OR REPLACEMENT AS PROVIDED UNDER THIS WARRANTY IS THE PURCHASER’S SOLE AND EXCLUSIVE REMEDY.**

Limitation of Liability

FLEX SHALL NOT BE LIABLE FOR SPECIAL, INDIRECT, INCIDENTAL OR CONSEQUENTIAL DAMAGES, LOSS OF WAY, REGARDLESS OF WHETHER SUCH CLAIM IS BASED IN CONTRACT, WARRANTY, TORT, NEGLIGENCE, STRICT LIABILITY OR ANY OTHER THEORY OF LIABILITY, EVEN IF FLEX HAS BEEN ADVISED OF THE POSSIBILITY OF SUCH DAMAGES.

Further, in no event shall the liability of Flex exceed the individual price of the Product on which liability is asserted. As Flex has no control over use, setup, assembly, modification or misuse, no liability shall be assumed nor accepted for any resulting damage and/or injury. By the act of use, setup or assembly, the user accepts all resulting liability. If you as the purchaser or user are not prepared to accept the liability associated with the use of the Product, purchaser is advised to return the Product immediately in new and unused condition to the place of purchase.

Law

These terms are governed by Florida law (without regard to conflict of law of principals). This warranty gives you specific legal rights, and you may also have other rights which vary from state to state. FLEX RESERVES THE RIGHT TO MODIFY THIS WARRANTY AT ANY TIME WITHOUT NOTICE.

Questions & Assistance

Contact us by:

E-Mail – support@flexinnovations.com

Phone – 1 (866) 310-3539

Inspection or Services

If this Product needs to be inspected or serviced and is compliant in the region you live and use the Product in, please contact your regional Flex authorized reseller. Pack the Product securely using the original shipping carton. Please note that both the inner and outer boxes need to be included. The inner box is not designed to withstand the rigors of shipping without additional protection from the outer shipping carton. Ship via a carrier that provides tracking and insurance for lost or damaged parcels, as Flex is not responsible for merchandise until it arrives and is accepted at our facility.

Warranty Requirements

For Warranty consideration, you must include your original sales receipt verifying the proof of purchase date. Provided any warranty conditions have been met, your Product or its defective parts will be replaced or serviced free of charge. Responsibility of shipping charges are as follows:

To Flex from customer, customer is responsible.

To Customer from Flex, Flex is responsible.

Service or replacement decisions are at the sole discretion of Flex.

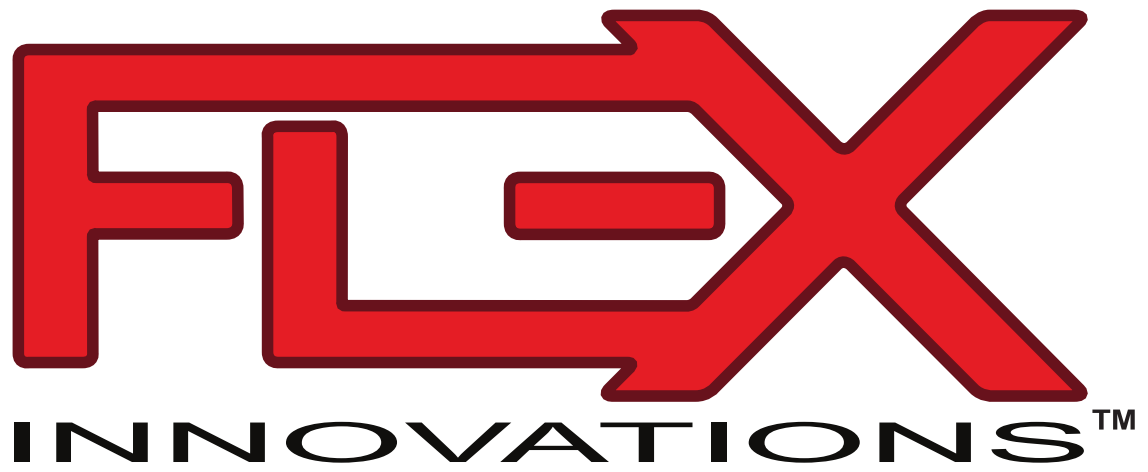

© 2021 Flex Innovations, LLC. All rights reserved.
Potenza™ is a trademarks of Flex Innovations LLC
Futaba and S.Bus are registered trademarks of Futaba Denshi Kogyo Kabushiki Kaisha Corporation of Japan.