

Discus - 2a

De Luxe

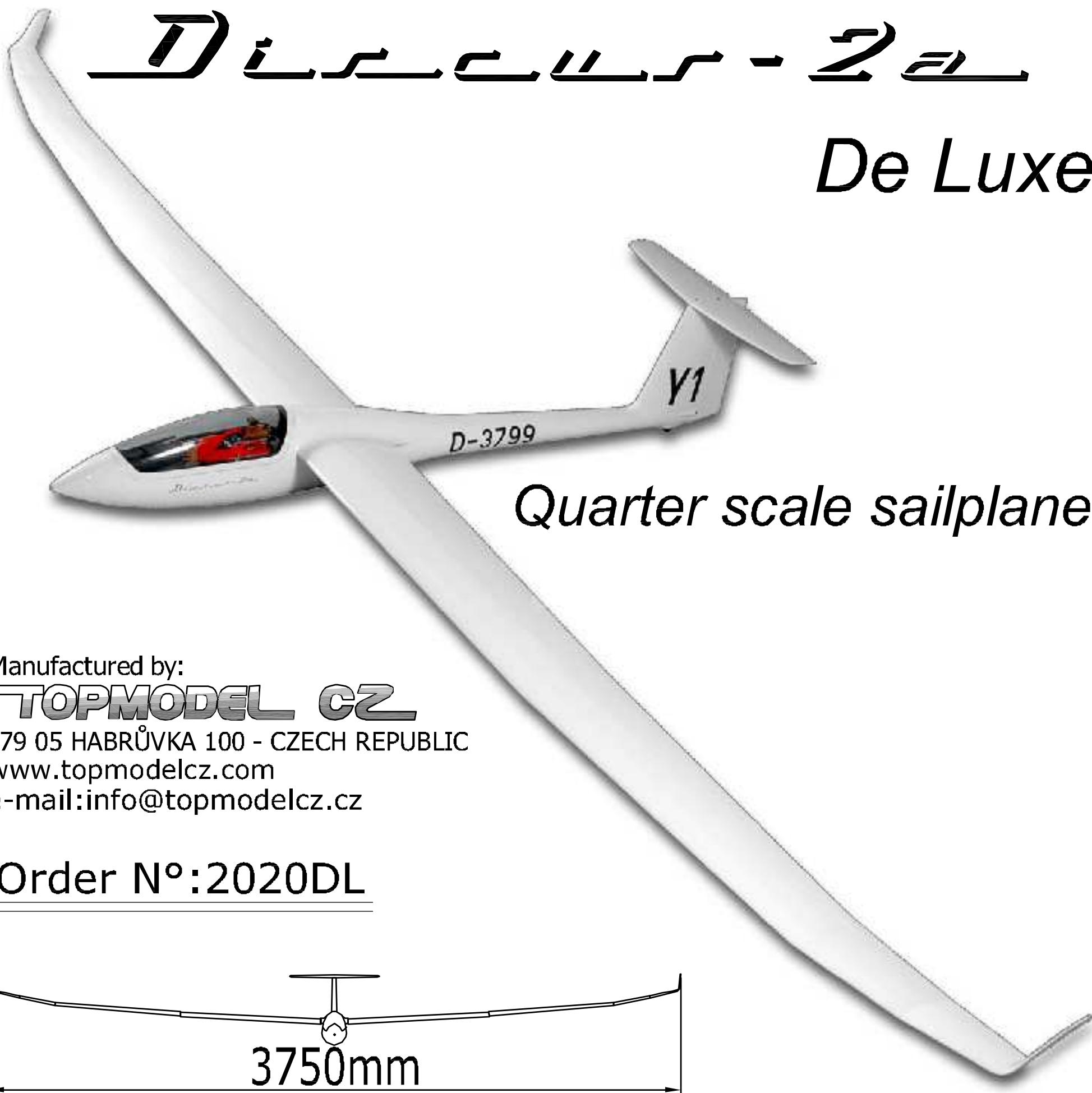

Quarter scale sailplane

Manufactured by:

TOPMODEL CZ

679 05 HABRŮVKA 100 - CZECH REPUBLIC

www.topmodelcz.com

e-mail: info@topmodelcz.cz

Order N°:2020DL

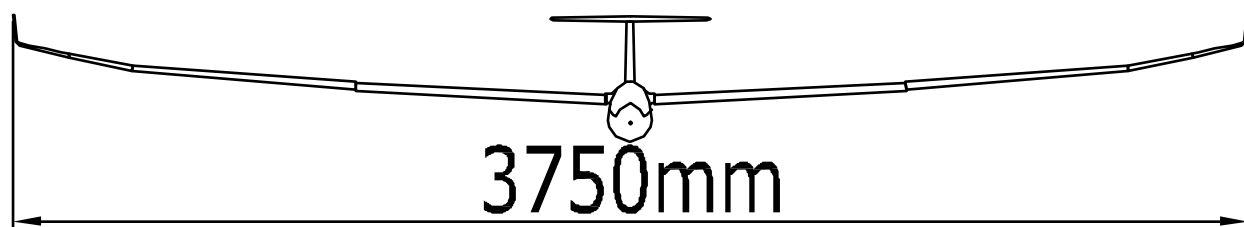

Radio system you'll need :

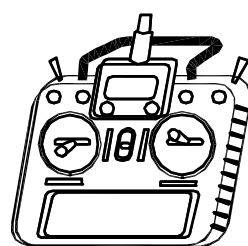
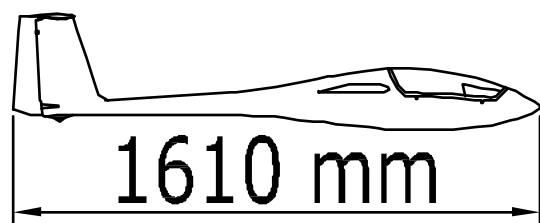

6 channel
with
8 servos

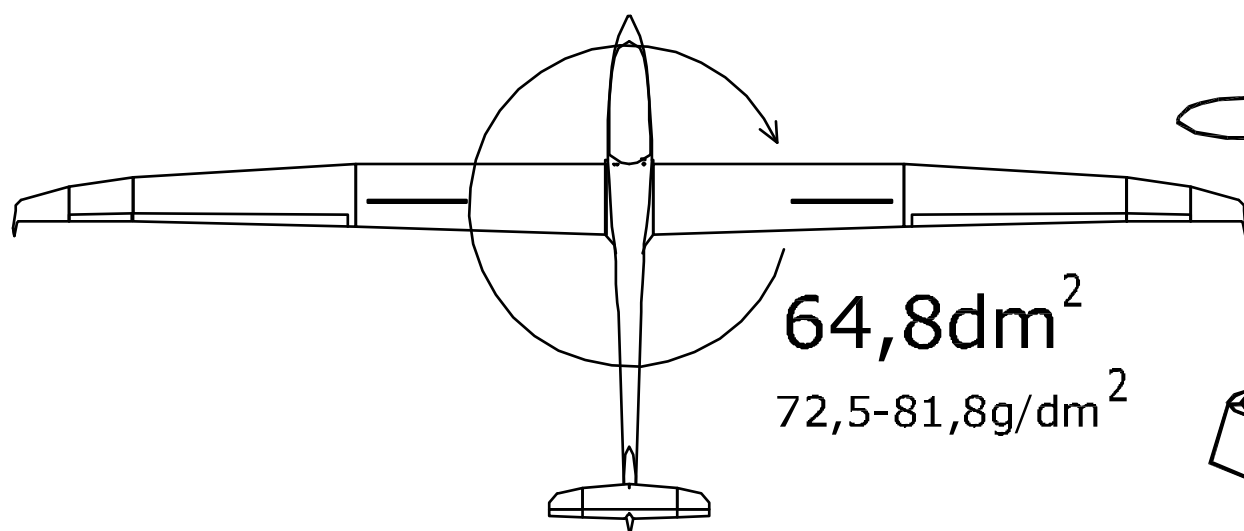

HQ3/14-13-12



4,7 - 5,3 kg

	GB	Parts list			
Part #	Part name	Material, dimensions	Loose	In bag	Installed
	building instructions		1	-	-
1	fuselage	fiberglass	1	-	-
1-2	servo tray	plywood 4x130x138mm	-	1	-
1-21	servo tray support	plywood 4mm	-	2	-
1-22	rudder link support	plywood 4mm	-	1	-
1-23	elevator servo tray	fibreglass 1x19x45mm	-	1	-
1-24	tow hook servo tray	plywood 4mm	-	3	-
1-101	retract gear	20116390	-	-	1
1-1015	retract gear pushrod	M3x55mm	-	1	-
1-1016	ball pin	203801	-	2	-
1-103	taiwheel	Ø37mm	-	-	1
1-104	tow hook	05013	-	-	1
1-1045	tow hook pushrod	steel M2	-	1	-
1-1046	clevis tow hook	steel M2, nut M2	-	1+1	-
1-1047	clutch	MPJ 2012BR	-	1	-
2	wing	foam core-abachi Oracover®covered	2	-	-
2-12	aileron	foam core-abachi Oracover®covered	-	-	2
2-13	aileron 2	foam core-abachi Oracover®covered	-	-	2
2-15	aileron joiner	steel Ø2 x 30mm	-	-	2
2-21	centering pin	steel Ø3mm	-	-	2
2-23	winglet	fibreglass	2	-	-
2-3	wing fixing	nylon	-	-	2
2-4	airbrake servo mount	polyuretan 13mm	-	4	-
2-41	airbrake servo top	sticker	-	2	-
2-5	aileron pushrod	M2 x 38mm	-	2	-
2-6	clevis	metal M2, nut M2	-	4+4	-
2-8	aileron horn	MPJ 2291	-	2	-
2-81	nut	MPJ 1005	-	2	-
2-9	cabling	02043-CB	-	-	2
24	wing joiner	steel Ø12 x 420mm	-	1	-
3	horizontal stabilizer	fibreglass	1	-	-
3-4	stabilizer screw	M4x20mm	-	2	-
3-5	elevator pushrod	M2	-	1	-
3-6F	ball pin	MPJ 2408	-	1	-
3-6R	clevis	metal M2, nut M2	-	1+1	-
3-7	clutch	MPJ 2012BR	-	1	-
3-8	elevator horn	MPJ 2291	-	1	-
4	fin	fibreglass	-	-	1
4-5	rudder pushrod	steel Ø1,5mm	-	-	1
4-6	threaded rod tip M2	MPJ 2762	-	-	1
4-8	rudder horn	MPJ 2291	-	-	1
6	canopy + frame		-	-	1
6-1	dashboard panel	fibreglass	-	-	1
6-2	seat	fibreglass	-	-	1
7	stickers		-	-	set

ATTENTION !!!

This model construction kit is not a toy and is not suitable for children under the age of 14. Incorrect use of this model could cause material damage or personal injury. You are fully responsible for your actions when you use this model. Fly at a safe distance from occupied zones. Before switching on the radio, be sure, that no one else is using the same frequency as you!

NB:

Although the wings are provided with a system which keeps them firmly fixed to the fuselage, you must stick some adhesive tape, half on the fuselage and half on the wing, the whole length of the chord, in order to ensure that in case of a shock or vibration the wing cannot move slightly away from the fuselage.

If the wing does move away from the fuselage, however little, you may well lose the electrical contact afforded by the multi-pin plug connecting the servo to the receiver, thus losing the use of both the ailerons and the air-brakes!

TOPMODEL CZ - 22

De Luxe

TOPMODEL CZ
 Výkres není v měřítku - Not scale !!!

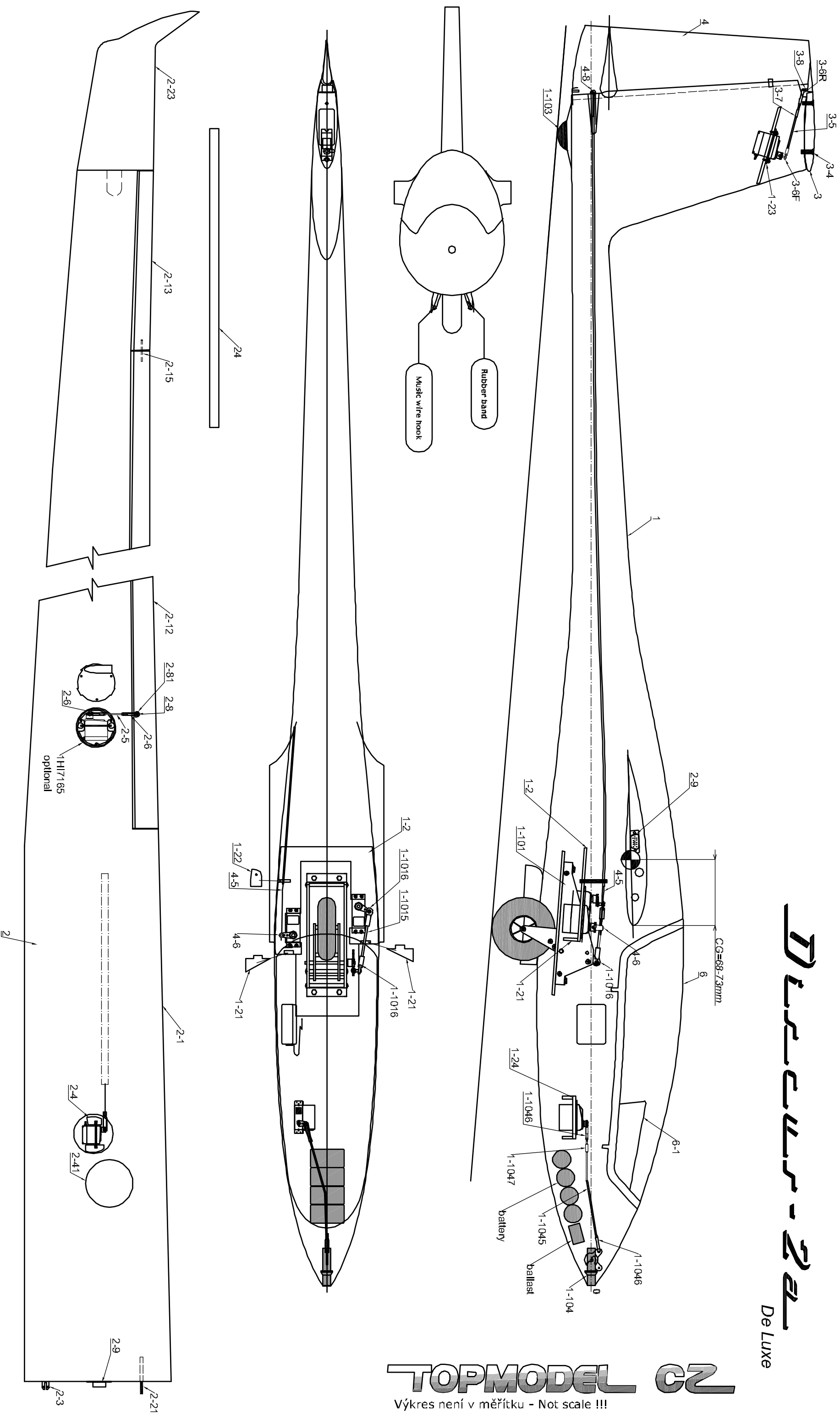

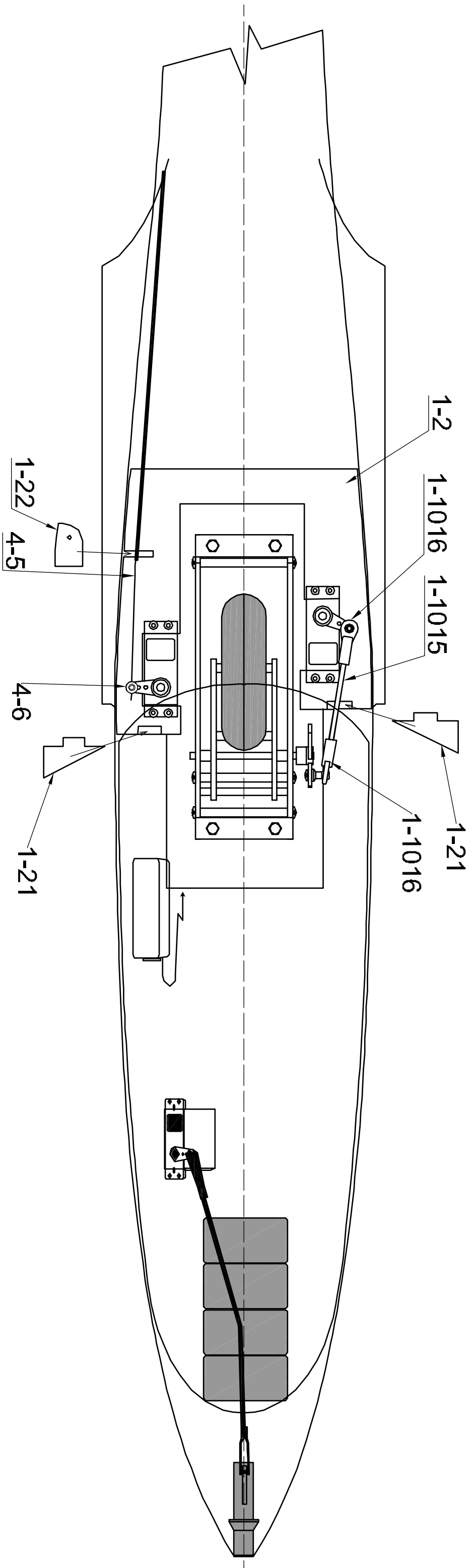
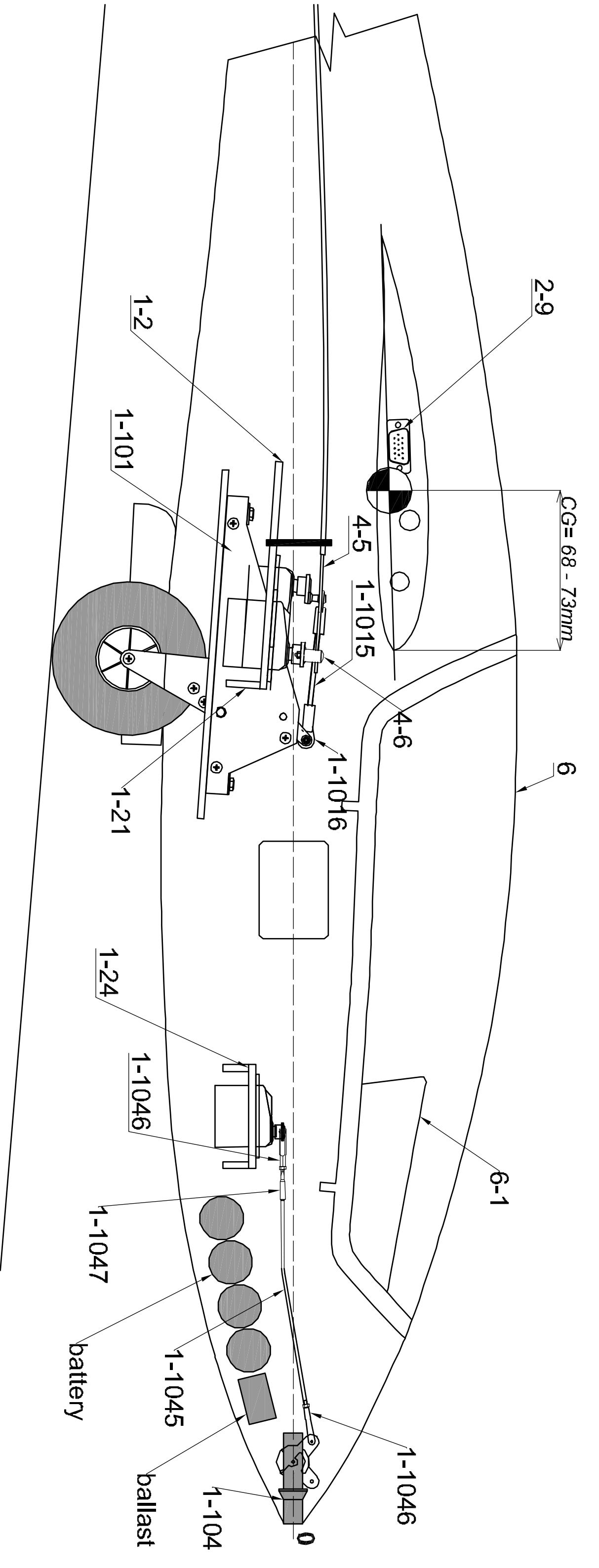

Wing servo instalation
Instalace serv křídla

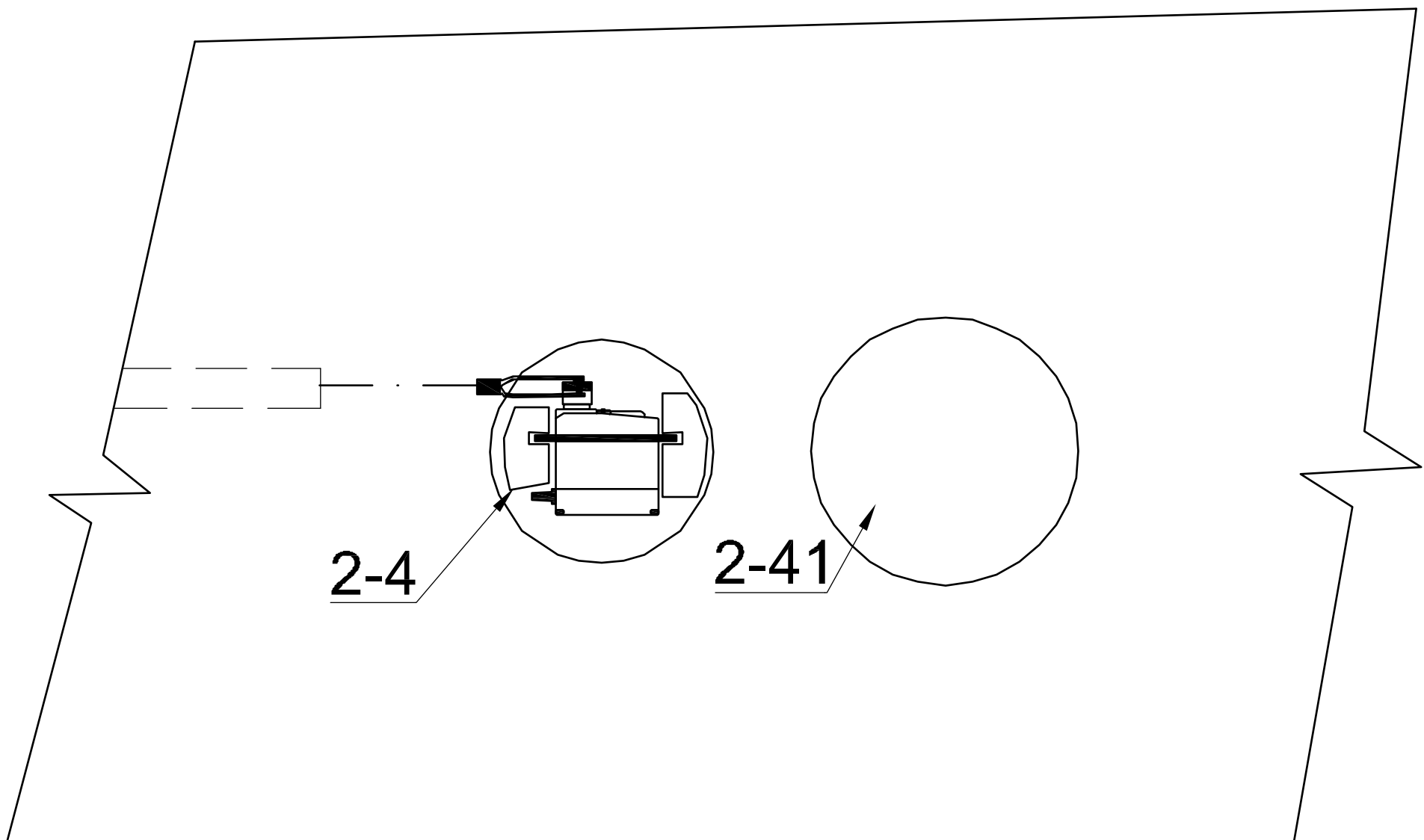
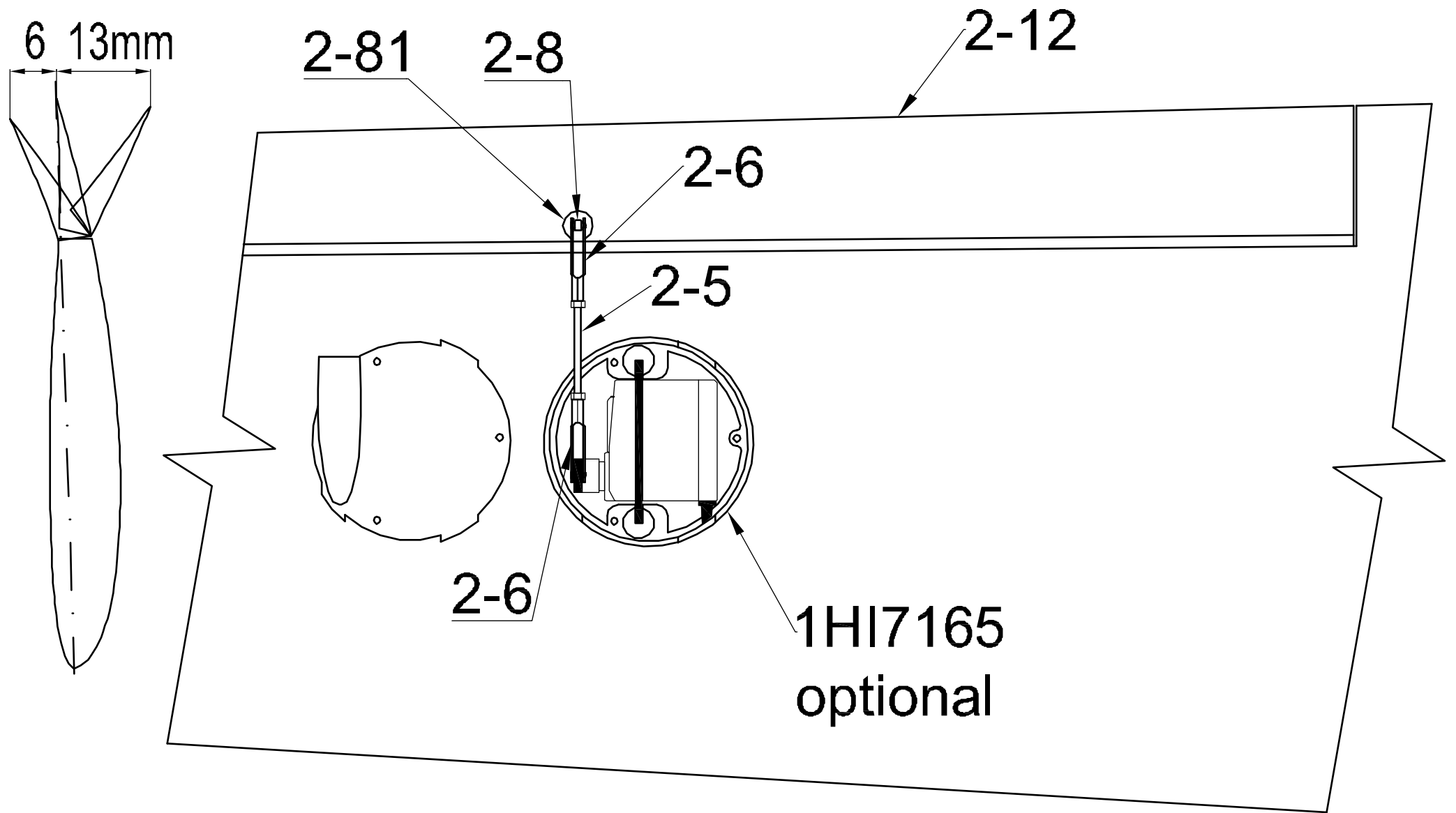

Elevator servo instalation
Instalace serva pro výškovku

